

Technical Information

Service - Dixon® Air King couplings are recommended for use on air lines for virtually any type of pneumatic equipment. The maximum recommended working pressure for Dixon Air King universal couplings is **150 PSI** or less at ambient temperature **70°F (21°C)**.

Features - Dixon Air King fittings have a universal head which is identical for all parts (hose ends, male NPT, and female NPT) within the 1/4" to 1" range. This enables any two fittings (within that range) to be directly connected regardless of hose shank or threaded size. Dixon Air King couplings with interlocking ferrule also have the standard Air King universal head, that enables any of the Air King with ferrule couplings to connect directly to any other Air King coupling within the 1/4" - 1" range. The ferrule comes attached to the fitting for easy installation. The ferrules can be swaged or crimped depending on your coupling installation equipment.

Connection - Connections are made by pushing two heads together and turning one quarter turn in a clockwise direction. When this is done and the heads have seated properly, the small holes ensure the flange on the side of each coupling head will line up. An Air King safety clip should be inserted at this point to assure the Air King couplings will not become accidentally disconnected. If a safety clip is not available, insert a cotter pin or wire type retainer through the holes. The fitting is now ready to be put into service.

Disconnection - Remove the safety clip, cotter pin, or wire. Press the heads firmly together and turn them counterclockwise. The heads will then separate. NEVER attempt to disconnect any hose while pressure is in the line.

Interchange - Although Air King couplings may interchange with other manufacturer's fittings, we do not recommend their use with other products. Not all locking heads are made to the same standards as Dixon Air King. Use with other brands of fittings may create an unsafe condition, due to poor design or worn equipment.

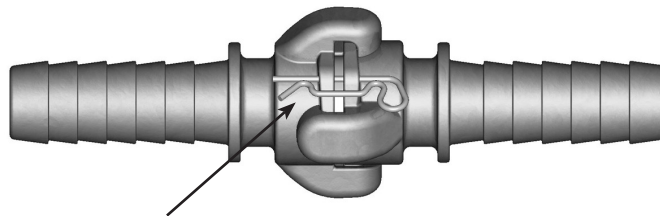

⚠ WARNING

The use of an Air King safety clip or wire type retainer is necessary to ensure Air King universal couplings will not become accidentally disconnected. This guarantees the fittings are properly connected because the safety pin will not go through the holes in mating flanges until couplings are locked in place. Only one Air King safety clip or wire type retainer is required for each Air King universal coupling.

To provide protection against coupling breakage and related hazards, Dixon recommends the use of a Whip Hose.

The Importance of Whip Hose

The constant vibration created by air tools, like air drills and pavement breakers, is destructive to air hose couplings, especially the quick-acting type. To provide a safer working environment, connect one end of a 3' to 10' length of air hose to the tool using Dixon's No. 3500 Steel Nipple. This nipple is designed to specifically handle vibration applications. Connect the other end of hose to the air supply using the standard quick-acting coupling. The Whip Hose should remain permanently connected to the tool.

Air King meets pressure requirements as specified in A-A-59553 commercial item description superseding Mil Spec. WWC-633D.

NOTE: All dimensions provided throughout this brochure are nominal.

Safety



Dixon® couplings and retention devices are designed to work safely for their intended use. The selection of the proper hose, coupling and retention device, and the proper application of the coupling to the hose are of utmost importance.

Users must consider the size, temperature, application, media, pressure, and hose and coupling manufacturer's recommendations when selecting the proper hose assembly components. Dixon recommends that all hose assemblies be tested in accordance with the Association for Rubber Products Manufacturer's (ARPM) recommendations and be inspected regularly (before each use) to ensure that they are not damaged or have become loose. Visit ARPMINC.com for more information.

Where safety devices are integral to the coupling, they must be working and utilized. The use of supplementary safety devices such as safety clips or safety cables are recommended.

If any problem is detected, couplings must be removed from service immediately.

Dixon is available to consult, train, and recommend the proper selection and application of all fittings we sell. We strongly recommend that distributors and end users make use of Dixon's Testing and Recommendation Services. Call 877.963.4966 or visit dixonvalve.com to learn more.

Air King 2-Lug Male NPT Ends

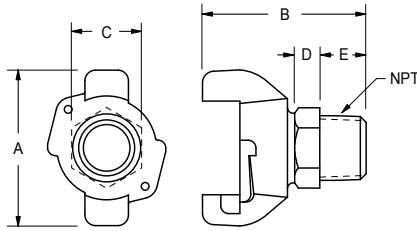

Features

- Supplied with safety clip
- Supplied with rubber washer, part # AWR4

Specification

- Pressure rating: 150 PSI at ambient temperature 70°F (21°C)

Size	Iron Part #	Optional Qty	Brass Part #	Optional Qty	316 Stainless Steel Part #
1/4"	AMB1	25	ABB1	25	---
3/8"	AMB	25	ABB	25	RAMB
1/2"	AM2	50	---	50	RAM2
3/4"	AM7	50	---	50	RAM7
1"	AM12	50	---	50	RAM12

Dimensions

Size	A	B	C	D	E	NPT
1/4"	2-1/2"	2-9/16"	1"	7/16"	5/8"	1/4"
3/8"	2-1/2"	2-9/16"	1"	7/16"	5/8"	3/8"
1/2"	2-1/2"	2-11/16"	1-1/8"	1/2"	13/16"	1/2"
3/4"	2-1/2"	2-13/16"	1-3/8"	9/16"	7/8"	3/4"
1"	2-1/2"	2-7/8"	1-1/2"	5/8"	7/8"	1"

2-Lug Female NPT Ends

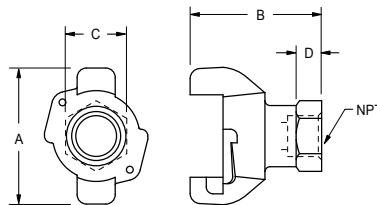

Features

- Supplied with safety clip
- Supplied with rubber washer, part # AWR4

Specification

- Pressure rating: 150 PSI at ambient temperature 70°F (21°C)

Size	Iron Part #	Optional Qty	Brass Part #	Optional Qty	316 Stainless Steel Part #
1/4"	AMC1	25	ABC1	25	---
3/8"	AMC	25	ABC	25	RAMC
1/2"	AM3	50	---	50	RAM3
3/4"	AM8	50	---	50	RAM8
1"	AM13	50	---	50	RAM13

Dimensions

Size	A	B	C	D	NPT
3/8"	2-1/2"	2-7/16"	1-1/8"	3/8"	1/4"
1/2"	2-1/2"	2-7/16"	1-1/8"	3/8"	3/8"
5/8"	2-1/2"	2-7/16"	1-1/8"	3/8"	1/2"
3/4"	2-1/2"	2-1/2"	1-7/16"	3/8"	3/4"
1"	2-1/2"	2-1/16"	1-5/8"	3/8"	1"

Air King

2-Lug Hose Ends

Features

- Supplied with safety clip
- Supplied with rubber washer, part # AWR4

Specification

- Pressure rating: **150 PSI** at ambient temperature **70°F (21°C)**

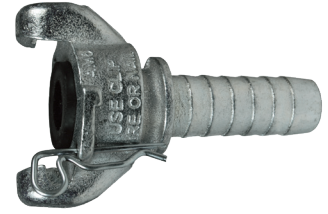
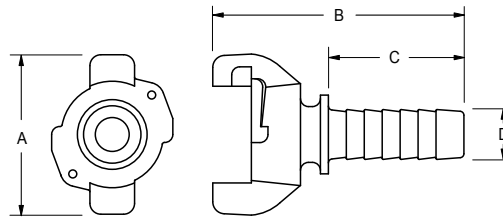

Size	Iron Part #	Optional Qty	Brass Part #	Optional Qty	316 Stainless Steel Part #
3/8"	---	25	---	25	RAMH
1/2"	AM1	50	---	50	RAM1
5/8"	AM5	50	AB5	50	---
3/4"	AM6	50	---	50	RAM6
1"	AM11	50	---	50	RAM11

Dimensions

Size	A	B	C	D
3/8"	2-1/2"	3-1/2"	1-11/16"	7/16"
1/2"	2-1/2"	3-7/16"	1-5/8"	17/32"
5/8"	2-1/2"	4-1/4"	2-7/16"	11/16"
3/4"	2-1/2"	3-15/16"	2-1/8"	25/32"
1"	2-1/2"	4-25/32"	2-13/16"	1-1/16"

Air King Clamps

Specification

- Torque values for clamps are based on dry bolts, the use of lubricant on bolts will adversely effect clamp performance

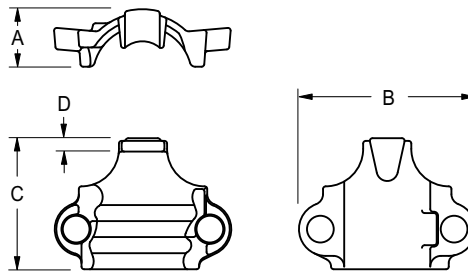

Hose I.D.	Hose O.D.		Plated Iron Part #	Torque ft. lbs.	Optional Qty
	from	to			
3/8"	44/64"	56/64"	CD ²	6	100
1/2"	1"	1-12/64"	A4 ²	6	50
3/4"	1-8/64"	1-20/64"	A9 ²	21	50
1"	1-20/64"	1-32/64"	A10 ^{1,2}	21	50
	1-32/64"	1-52/64"	A14	21	50

¹ Can be used with AM6 and AM11

² Global investment cast carbon steel

Dimensions

Size	A	B	C	D
3/8"	9/16"	1-11/16"	1-7/16"	3/16"
1/2"	11/16"	2-1/16"	1-17/32"	5/32"
3/4"	7/8"	2-13/16"	1-21/32"	1/8"
1"	7/8"	2-19/32"	1-15/16"	9/32"
1"	1"	3-1/32"	2-1/4"	5/32"

Air King

2-Lug Blank Ends

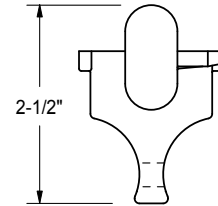
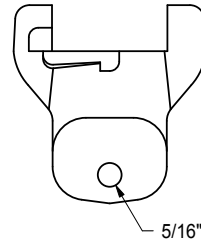
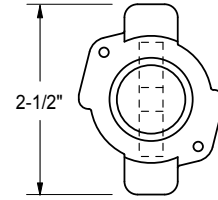

Features

- Supplied with safety clip
- Supplied with rubber washer, part # AWR4

Specification

- Pressure rating: **150 PSI** at ambient temperature **70°F (21°C)**

Iron Part #	Optional Qty	316 Stainless Steel Part #
AM0	25	RAM0 ¹

¹ Global investment cast

2-Lug Triple Connections

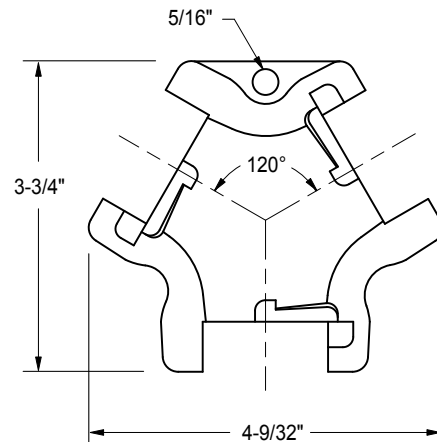

Features

- Supplied with safety clip
- Supplied with rubber washer, part # AWR4

Specification

- Pressure rating: **150 PSI** at ambient temperature **70°F (21°C)**

Iron Part #	Optional Qty
AM10	25

Air King 4-Lug Quick Acting Couplings

4-Lug Hose Ends

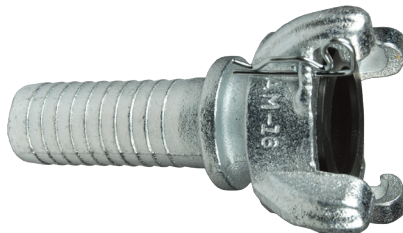

Features

- Supplied with safety clip and rubber washers
- Use with Boss® clamps, see page 11
- Must use safety clips, safety clips are same size for both 2-lug and 4-lug 

Specification

- Pressure rating: 150 PSI at ambient temperature 70°F (21°C)

Size	Iron Part #	Optional Qty
1-1/4"	AM16	25
1-1/2"	AM21	25
2"	AM26	10

Air King 4-Lug Quick Acting Couplings



4-Lug Female NPT Ends

Size	Iron Part #	Optional Qty
1-1/4"	AM18	25
1-1/2"	AM23	25
2"	AM28	25

NOTE: Air King is for air and water service only. Warning: Never use any Air King coupling for steam service! None of Dixon®'s brochure information is to be interpreted to mean that this type of coupling is suitable for use on steam hose. 

Air King with Ferrule



Features

- Design provides quick, easy, and effective coupling of air hose
- Interlocking ferrule can be crimped or swaged to achieve maximum coupling sealing and retention with a low-profile streamline appearance. For crimp or swage diameter recommendations go to dixonvalve.com
- For air and water service only

Specification

- Working pressure: 150 PSI at ambient temperature 70°F (21°C)

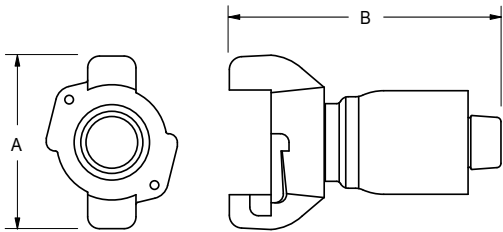

Dimensions

Size	A	B
1/2"	2-1/2"	3-7/16"
3/4"	2-1/2"	3-15/16"
1"	2-1/2"	4-25/32"

Size	Hose O.D.		Global Plated Steel	Iron Part #	316 Stainless Steel Part #
	From	To			
1/2"	5/4/64"	1-2/64"	---	AM1WF	RAM1WF
3/4"	1-4/64"	1-22/64"	GAM6WF	AM6WF	RAM6WF
1"	1-18/64"	1-34/64"	---	AM11WF-1	---
1"	1-30/64"	1-46/64"	---	AM11WF	---
2"	2-28/64"	2-40/64"	---	AM26WF	---

Air King with Gauge Port



Features

- Drilled with 1/4" NPT port for mounting a gauge
- Gauge sold separately

Size	Iron Part #	316 Stainless Steel Part #
3/4"	AM7T	RAM7T

Air King Couplings

Swivel Hose End



Features

- Interchanges with other Air King fittings
- Includes a heavy-duty, free-turning joint that swivels under pressure to prevent hose kinking

- For air and water service only

Specification

- Working pressure: 150 PSI at ambient temperature 70°F (21°C)

Size	Iron Part #
3/4"	AM6SWIV

Swivel Male NPT Ends



Size	Iron Part #
1/2"	AM2SWIV
3/4"	AM7SWIV

Swivel Female NPT End



Size	Iron Part #
3/4"	AM8SWIV

NOTE: Air King is for air and water service only. Warning: Never use any Air King coupling for steam service! None of Dixon's catalog information is to be interpreted to mean that this type of coupling is suitable for use on steam hose. 

Global Air King

Features

- Supplied with safety clip and rubber washers
- Use with Air King clamps; see page 5
- Use with Global Air King ferrules on page 10
- Not to be used for steam service 
- Must use safety clips, safety clips are same size for both 2-lug and 4-lug Air King couplings, see page 12

Specification

- Pressure rating: **150 PSI** at ambient temperature **70°F (21°C)**

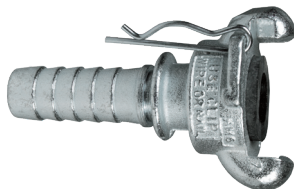

2-Lug Hose Ends

Size	Plated Steel Part #	Iron Part #	Brass Part #	Pkg Qty
3/8"	---	AMH	GABH	25
1/2"	GAM1	---	GAB1	50
3/4"	GAM6	---	GAB6	50
1"	GAM11	---	GAB11	50



2-Lug Male NPT Ends

Size	Plated Steel Part #	Brass Part #	Pkg Qty
1/2"	GAM2	GAB2	25
3/4"	GAM7	GAB7	50
1"	GAM12	GAB12	50



2-Lug Female NPT Ends

Size	Plated Steel Part #	Brass Part #	Optional Qty
1/2"	GAM3	GAB3	25
3/4"	GAM8	GAB8	50
1"	GAM13	GAB13	50

Global Air King

2-Lug Blank End



Plated Steel Part #	Brass Part #	Optional Qty
GAM0	GAB0	25

2-Lug Triple Connection



Plated Steel Part #	Brass Part #	Optional Qty
GAM10	GAB10	25

4-Lug Hose Ends

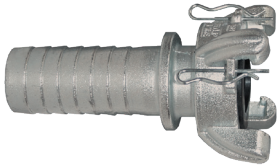

Size	Plated Steel Part #	Optional Qty
1-1/4"	GAM16	25
1-1/2"	GAM21	25
2"	GAM26	10

4-Lug Female NPT Ends

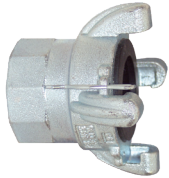

Size	Plated Steel Part #	Optional Qty
1-1/4"	GAM18	25
1-1/2"	GAM23	25
2"	GAM28	20

NOTE: Air King is for air and water service only. Warning: Never use any Air King coupling for steam service! None of Dixon®'s brochure information is to be interpreted to mean that this type of coupling is suitable for use on steam hose. 

Global Air King Ferrules



Features

- Low profile streamline appearance with maximum retention
- Lightweight
- Can be crimped
- Designed for use with global Air King fittings on page 9
- Reference dixonvalve.com for crimp recommendations and ferrule O.D. ranges

Size	Ferrule I.D.	Plated Steel Part #
1/2"	0.906"	CCF0906
	1.120"	CCF1120
3/4"	1.149"	CCF1149
	1.190"	CCF1190
	1.218"	CCF1218
	1.246"	CCF1246
	1.438"	CCF1438
1"	1.469"	CCF1469
	1.500"	CCF1500
	1.531"	CCF1531

Boss® Clamps

⚠ WARNING

The bolts used in the Boss interlocking clamps are not standard bolts. They vary from standard bolts in their length, diameter, overall thread length, and material hardness. These bolts can be retorqued, but it is not recommended that the bolts or clamps be reused, as they are designed for a single bend only. Dixon recommends using only factory supplied replacement bolts.

Torque values for clamps are based on dry bolts. The use of lubricant on bolts will adversely effect clamp performance. Do not lubricate nuts and bolts.

Feature

- Replacement nuts and bolts are available; contact Dixon for more information

Specifications

- Recommended for steam service up to **450°F (232°C)**
- Recommended torque rating in ft. lbs.



4-Bolt Type
2-Gripping Fingers



4-Bolt Type
4-Gripping Fingers

Hose I.D.	Hose O.D.		Zinc Plated Iron Part #	Opt Qty	Stainless Steel Part #	Torque ³	Brass Part #	Torque
	From	To						
1-1/4"	1-32/64"	1-50/64"	BU18	10	---	40	---	--
1-1/4"	1-44/64"	1-56/64"	187 ¹	10	---	21	---	--
1-1/4"	1-50/64"	2-6/64"	BU19	10	---	40	---	--
1-1/4"	1-56/64"	2-4/64"	206 ¹	20	---	21	---	--
1-1/4"	2-8/64"	2-24/64"	B19	10	RB19	40	---	28
1-1/2"	1-52/64"	2"	BU22	10	---	40	---	--
1-1/2"	2"	2-14/64"	B22	10	---	40	---	--
1-1/2"	2"	2-8/64"	212 ¹	10	---	21	---	--
1-1/2"	2-4/64"	2-16/64"	225 ¹	10	---	40	---	--
1-1/2"	2-12/64"	2-24/64"	BU24	10	RBU24	40	---	28
1-1/2"	2-24/64"	2-36/64"	B24	10	RB24	40	---	--
1-1/2"	2-36/64"	2-48/64"	B25	10	---	40	---	--
2"	2-16/64"	2-32/64"	250 ^{1,4}	10	---	40	---	--
2"	2-22/64"	2-34/64"	BU28	10	---	60	---	--
2"	2-32/64"	2-48/64"	275 ^{1,4}	10	---	40	---	--
2"	2-32/64"	2-50/64"	BU29	10	RBU29	60	BBU29 ²	40
2"	2-48/64"	3-4/64"	B29	10	RB29	60	---	--
2"	2-48/64"	3-4/64"	306 ^{1,4}	10	---	60	---	--
2"	3-6/64"	3-28/64"	B30	5	---	60	---	--

¹ 4 gripping fingers and 4 bolts

² Will become obsolete as inventory is depleted

³ Torque applies to plated iron and stainless steel clamps

⁴ Not to be used with GF81, GB26, WF81, B26, RGF81, RGB26, BGF81, BGB26, RWF81, and RB26

Air King Accessories

2-Lug Washers

Features

- 2-lug couplings use the same size washer
- Neoprene is oil resistant

Specifications

- Rubber temperature range: **-20°F to 160°F (-29°C to 71°C)**
- Neoprene temperature range: **-20°F to 190°F (-29°C to 88°C)**



AWR4



AWS6

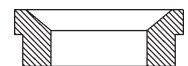

Style	Rubber Part #	Neoprene Part #	Pkg Qty
2 lug	AWR4 ¹	AWS6	50

¹ Made from styrene-butadiene (SBR)

4-Lug Washer



Feature

- 4-lug couplings use the same size washer

Specification

- Rubber temperature range: **-20°F to 160°F (-29°C to 71°C)**

Style	Rubber Part #
4 lug	AWR14

Air King Accessories

Features

- The use of an Air King safety clip or wire type retainer is necessary to ensure couplings will not become accidentally disconnected, this guarantees the fittings are properly connected as the pin will not go through the holes in the mating flanges until couplings are locked in place
- Only one Air King safety clip or wire type retainer is required for each Air King universal coupling
- Sold in package quantities only

Standard Safety Clip



Feature

- Same size clip can be used for all coupling sizes

Wire Diameter	Part #	Pkg Qty
.080	AC1	25

Safety Pin



Feature

- Heavy duty, oversized

Wire Diameter	Part #
.058	AKSP1
.091	AKSP25

Stainless Steel Clip



Feature

- Same size clip can be used for all coupling sizes

Wire Diameter	Part #
.072	AC7

Lanyards



Features

- Synthetic cord
- Same size for all coupling sizes

Part #	Pkg Qty
ACL8	25



Features

- Breaking strength: 160 lbs.
- Overall length: 7" eye to eye

304 Stainless Part #
LR7

In-Line Lubricators



Features

- Protects portable or stationary air tools by efficiently oiling the tool mechanisms; each time an air tool is operated a fine mist of oil is injected into it along with the air from the compressor
- Installation is recommended within 25' of the tool to be lubricated, refer to the arrow for proper air flow direction
- Transparent sight disc allows visual inspection of oil level
- Oil flow regulated by screwdriver screw adjustment; minimum flow rate is 30 SCFM
- Not recommended for constant flow applications
- For reciprocating tools only
- Type of oil to use: any petroleum-based, non-detergent light weight oil (SAE 10/150SSU) which will readily break up into a mist, i.e., Mobil DTE light or comparable oil, do not use any synthetic oil or oils containing additives or solvents

NPT Size	Oil Capacity	Maximum Working Pressure at Ambient Temperature 70°F (20°C)	Air Flow at 70 PSI	Aluminum Part #
1/2"	1.4 fluid oz.	500 PSI	30 SCFM	PL300
3/4"	3.7 fluid oz.	200 PSI	70 SCFM	PL400
3/4"	11.0 fluid oz.	300 PSI	70 SCFM	PL400L
1"	16.0 fluid oz.	250 PSI	100 SCFM	PL500

Replacement Parts

Description	Part #
(A) oil adjustment valve assembly	851661
(B) valve gasket	452531
(C) fill plug	452525
(D) fill plug O-ring	700013-214
(E) sight disk	452532
(F) sight disk seal	700013-016
(G) sight disk lock nut	452533

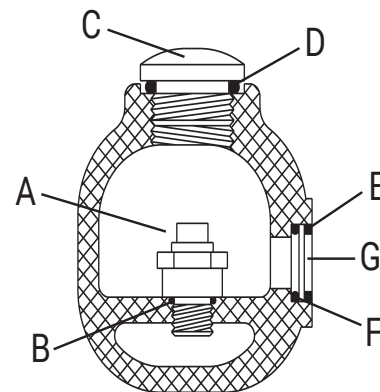

Compressor Y

Feature

- Converts a single supply source to a dual outlet

Female NPT Inlet (1)	Male NPT Outlets (2)	Iron Part #
1"	3/4"	Y10075



ASME Air Receiver Manifolds

Features

- 7-gallon capacity
- Painted safety orange
- All openings are female NPT thread
- Special configurations available

Specifications

- Working pressure: **200 PSI**
- Built to ASME Code, National Board registered
- Conforms to OSHA standards 1910.169 and 1926.306

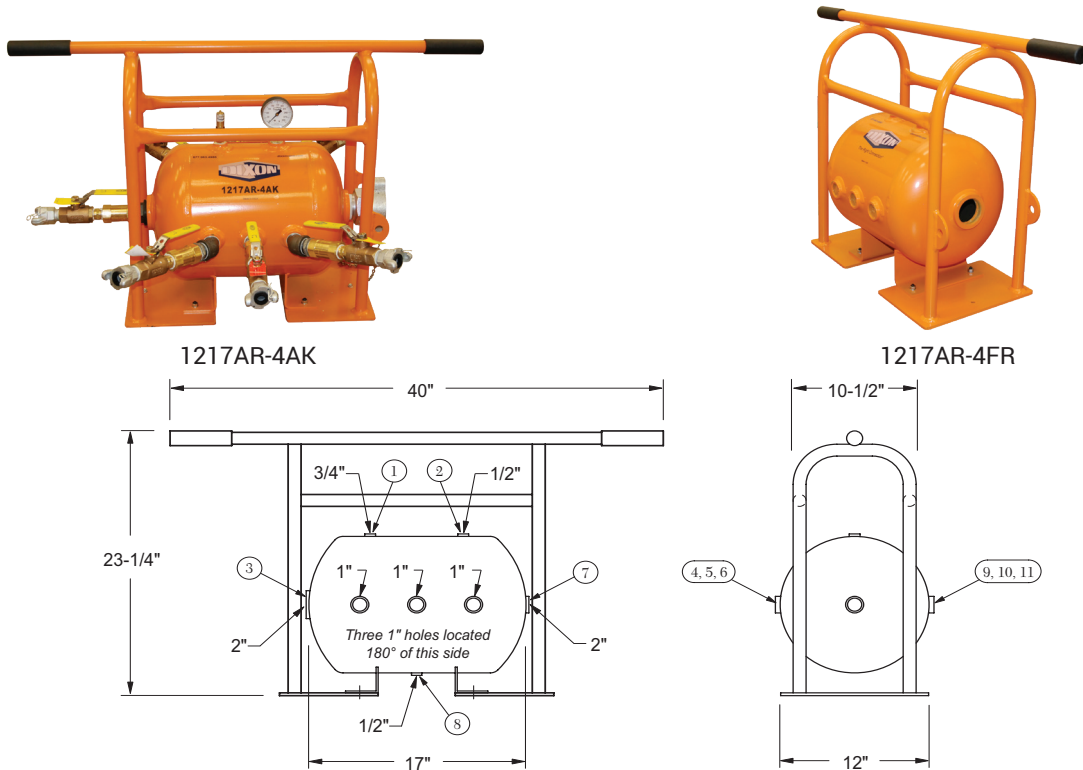

Dixon® 1217AR-4AK air receiver manifold assembly with Air King outlet ports includes the following components:

Part # / Locations	Qty	Description
1217AR-4	1	ASME compressed air receiver
Location 1	1	3731204C 3/4" male x 1/4" female hex bushing
Location 2	1	GL345 0-300 PSI gauge
Location 3	1	3730804C 1/2" male x 1/4" female hex bushing
Locations 4, 5, 6, 9, 10, 11	1	SV200 safety pop-off valve
Location 7	1	GM28 2" male spud
Location 8	1	B27SC wing nut cap
	6	HB1075G 1" male x 3/4" female bushings
	6	3701212C 3/4" brass hex nipples
	6	BBLV75 ball valves
	6	SCVS6 safety shut-off valves
	6	AM7 Air King universal couplings
	4	SE45100 45° street elbow (1 each in locations 4, 6, 9 and 11 only)
	1	HB2075 2" male x 3/4" female bushing
	1	3701212C 3/4" brass hex nipples
	1	BBLV75 ball valve
	1	SCVS6 safety shut-off valve
	1	AM7 Air King universal coupling
	1	3730804C 1/2" male x 1/4" female hex bushing
	1	D04 1/4" drain cock
	---	---
1217AR-4AK	1	7-gallon ASME compressed air receiver manifold complete assembly with Air King Tank and Frame only
1217AR-4FR	1	7-gallon ASME compressed air receiver with frame only

King Cable®

Application

- When hose, couplings, or clamps fail, or there is an accidental separation of the assembly, King safety cables minimize damage to equipment and injuries to operators.

Features

- Must be installed in the extended position (no slack)
- Cable reaches across hose fittings to provide standby safety for hose
- Spring-loaded loops in the cable ends open easily to pass over the couplings for a firm grip on the hose
- No tools needed - easy to install and remove
- Cables shipped with safety restraint labels attached
- Highly resistant to rust and corrosion
- Hose-to-hose or hose-to-rigid outlet

Materials

- For WB1, WB3, WA2, WA4, WSR1, WSR3, WSR2, WSR4, WSR1C, WB1C, WSR1E:
 - wire rope - galvanized carbon steel
 - ferrules - aluminum
 - springs - galvanized carbon steel
- For WB1SS, WB3SS, WA2SS, WA4SS, WSR1SS, WSR2SS, WSR3SS, WSR4SS:
 - wire rope - 304 stainless steel
 - ferrules - copper
 - springs - 304 stainless steel
- For WA2B:
 - wire rope - galvanized carbon steel
 - ferrules - copper
 - springs - galvanized carbon steel

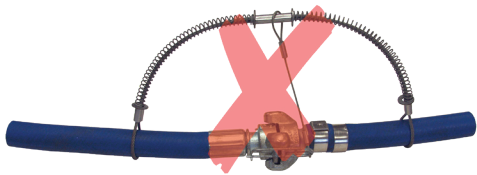

Incorrect installation

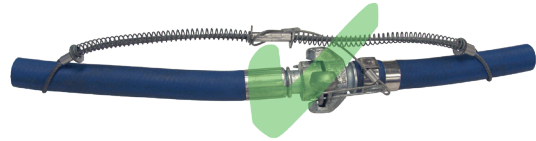

Correct installation

Specification

- Maximum operating pressure: **200 PSI**

Hose-to-Tool Service



Hose end

Tool end

Hose I.D.	Cable	Length	Maximum Working Pressure (PSI)	Steel Part #	Stainless Steel Part #
1/2" - 1-1/4"	1/8"	20-1/4"	200	WSR1	WSR1SS
1/2" - 2"	3/16"	28"	200	WSR3	WSR3SS
1-1/2" - 3"	1/4"	38"	200	WSR2	WSR2SS
4"	3/8"	44"	200	WSR4	WSR4SS

Hose-to-Hose Service



Hose end

Hose end

Hose I.D.	Cable	Length	Maximum Working Pressure (PSI)	Steel Part #	Stainless Steel Part #
1/2" - 1-1/4"	1/8"	20-1/4"	200	WB1	WB1SS
1/2" - 2"	3/16"	28"	200	WB3	WB3SS
1-1/2" - 3"	1/4"	38"	200	WA2	WA2SS
4"	3/8"	44"	200	WA4	WA4SS

King Cable Options



WB1C - WB1 with safety clip and lanyard



WSR1E - WSR1E with stainless steel marine eye

Hose I.D.	Cable	Part #	Description	Maximum Working Pressure (PSI)
1/2" - 1-1/4"	1/8"	WSR1C	WSR1 with safety clip and lanyard used to lock Air King couplings	200
1/2" - 1-1/4"	1/8"	WB1C	WB1 with safety clip and lanyard used to lock Air King couplings	200
1/2" - 1-1/4"	1/8"	WSR1E	WSR1 with stainless steel safety marine eye used to connect safety cable to a bolt on tool	200
1-1/2" - 3"	1/4"	WA2B	WA2 with bronze/copper ferrule for special environmental conditions	200

King Safety Whipsocks

Applications

- Ideally suited for applications where the media being transferred is under higher working pressures such as air, water, hydraulic, and slurry

Features

- King safety whipsocks keep the hose under control in the event of a high-pressure hose assembly failure
- Dual anchor points secured beyond the fittings eliminate hose whip
- Be sure the anchoring points are rated for the application
- Galvanized steel woven stockings extend down the hose to grip securely over a larger area preventing whip, abrasion, and wear
- Securing both eye-to-rigid or eye-to-eye anchor points reduce whip in the event of a hose connection failure
- Contact Dixon® with questions regarding working pressure, available options, or custom configurations

Materials

- Wire rope: galvanized carbon steel
- Ferrules: aluminum



KSW40



KSW32

Size	O.D. Range	Length	Maximum Working Pressure PSI	Part #
3/8"	.315" - .5512"	15.75"	5,000	KSW06
1/2"	.5512" - .7874"	21.65"	3,000	KSW08
3/4"	.7874" - 1.181"	25.20"	2,000	KSW12
1"	1.181" - 1.575"	34.25"	1,500	KSW16
1-1/4"	1.575" - 1.969"	38.19"	1,000	KSW20
1-1/2"	1.969" - 2.362"	49.21"	700	KSW24
2"	2.362" - 2.756"	51.18"	1,300	KSW32
2-1/2"	2.756" - 3.346"	53.15"	800	KSW40
3"	3.346" - 3.937"	72.44"	750	KSW48
3-1/2"	3.937" - 4.724"	72.05"	550	KSW56
4"	4.724" - 5.512"	86.61"	550	KSW64
6"	5.512" - 7.087"	93.31"	250	KSW96

Whip Hose Assemblies

7/8"-24 Male Threaded Bent Stem Swivel x Global Air King Fitting

Application

- Designed to be threaded into a pneumatic tool to better handle the impact and vibration often associated with these applications

Features

- The bent stem swivel is hardened and fits the following tool brands: Ingersoll-Rand, Thor, Black & Decker, Harper, Jet, Texas Pneumatic, Kent, and Sullair
- The whip hose should stay with the air tool, like a power cord stays with an appliance

Specifications

- Working pressure: **150 PSI**
- Temperature range: **-4°F to 212°F (-20°C to 100°C)**

Size	I.D.	Length	Rubber Hose Part #
7/8"	1/2"	6'	WH50X6AKBS7



1/2" Male Threaded Bent Stem Swivel x Global Air King Fitting

Application

- Designed to be threaded into a pneumatic tool to better handle the impact and vibration often associated with these applications

Features

- The bent stem swivel is hardened and fits all tools with 1/2" female NPT thread
- The whip hose should stay with the air tool, like a power cord stays with an appliance

Specifications

- Working pressure: **150 PSI**
- Temperature range: **-4°F to 212°F (-20°C to 100°C)**

Size	I.D.	Length	Rubber Hose Part #
1/2"	1/2"	6'	WH50X6AKBS50



3/4" Male Threaded Bent Stem Swivel x Global Air King Fitting

Application

- Designed to be threaded into a pneumatic tool to better handle the impact and vibration often associated with these applications

Features

- The bent stem swivel is hardened and fits all tools with 3/4" female NPT thread
- The whip hose should stay with the air tool, like a power cord stays with an appliance

Specifications

- Working pressure: **150 PSI**
- Temperature range: **-4°F to 212°F (-20°C to 100°C)**

Size	I.D.	Length	Rubber Hose Part #
3/4"	3/4"	6'	WH75X6AK35



OSHA Regulations

Standards - 29 CFR, 1910.242 (partial):

(b) Compressed air used for cleaning - Compressed air shall not be used for cleaning purposes except where reduced to less than **30 PSI** and then only with effective chip guarding and personal protective equipment.

Standards - 29 CFR, 1915.131 (partial):

(e) Before use, pneumatic tools shall be secured to the extension hose or whip by some positive means to prevent the tool from becoming accidentally disconnected from the whip.

Standards - 29 CFR, 1926.302 (partial):

(b)(1) Pneumatic power tools shall be secured to the hose or whip by some positive means to prevent the tool from becoming accidentally disconnected.

(b)(2) Safety clips or retainers shall be securely installed and maintained on pneumatic impact (percussion) tools to prevent attachments from being accidentally expelled.

(b)(3) All pneumatically driven nailers, staplers, and other similar equipment provided with automatic fastener feed, which operate at more than **100 PSI** pressure at the tool shall have a safety device on the muzzle to prevent the tool from ejecting fasteners, unless the muzzle is in contact with the work surface.

(b)(4) Compressed air shall not be used for cleaning purposes except where reduced to **30 PSI** and then only with effective chip guarding and personal protective equipment which meets the requirements of Subpart E of this part. The **30 PSI** requirement does not apply for concrete form, mill scale, and similar cleaning purposes.

(b)(5) The manufacturer's safe operating pressure for hoses, pipes, valves, filters, and other fittings shall not be exceeded.

(b)(6) The use of hoses for hoisting or lowering tools shall not be permitted.

(b)(7) All hoses exceeding 1/2" inside diameter shall have a safety device at the source of supply or branch line to reduce pressure in case of hose failure.

Standards - 29 CFR, 1926.306:

(a) General requirements

(a)(1) Application. This section applies to compressed air receivers and other equipment used in providing and utilizing compressed air for performing operations such as cleaning, drilling, hoisting, and chipping. On the other hand, however, this section does not deal with the special problems created by using compressed air to convey materials nor the problems created when men work in compressed air as in tunnels and caissons. This section is not intended to apply to compressed air machinery and equipment used on transportation vehicles such as steam railroad cars, electric railway cars, and automotive equipment.

(a)(2) New and existing equipment.

(a)(2)(i) All new air receivers installed after the effective date of these regulations shall be constructed in accordance with the 1968 edition of the A.S.M.E. Boiler and Pressure Vessel Code Section VIII.

(a)(2)(ii) All safety valves used shall be constructed, installed and maintained in accordance with the A.S.M.E. Boiler and Pressure Vessel Code, Section VIII Edition 1968.

(b) Installation and equipment requirements

(b)(1) Installation. Air receivers shall be so installed that all drains, handholes, and manholes therein are easily accessible. Under no circumstances shall an air receiver be buried underground or located in an inaccessible place.

(b)(2) Drains and traps. A drain pipe and valve shall be installed at the lowest point of every air receiver to provide for the removal of accumulated oil and water. Adequate automatic traps may be installed in addition to drain valves. The drain valve on the air receiver shall be opened and the receiver completely drained frequently and at such intervals as to prevent the accumulation of excessive amounts of liquid in the receiver.

(b)(3) Gauges and valves.

(b)(3)(i) Every air receiver shall be equipped with an indicating pressure gauge (so located as to be readily visible) and with one or more spring-loaded safety valves. The total relieving capacity of such safety valves shall be such as to prevent pressure in the receiver from exceeding the maximum allowable working pressure of the receiver by more than 10 percent.

(b)(3)(ii) No valve of any type shall be placed between the air receiver and its safety valve or valves.

Standards - 29 CFR, 1926.603 (partial):

(a)(9) Steam hose leading to a steam hammer or jet pipe shall be securely attached to the hammer with an adequate length of at least 1/4" diameter chain or cable to prevent whipping in the event the joint at the hammer is broken. Air hammer hoses shall be provided with the same protection as required for steam lines.

(a)(10) Safety chains, or equivalent means, shall be provided for each hose connection to prevent the line from thrashing around in case the coupling becomes disconnected.

The regulations may be viewed in full on the OSHA website, osha.gov. Please check the website for updates.

Limited Warranty

DIXON® VALVE AND COUPLING COMPANY, LLC (herein called "Dixon") warrants the products described herein and manufactured by Dixon to be free from defects in material and workmanship for a period of one (1) year from date of shipment by Dixon under normal use and service. Its sole obligation under this warranty being limited to repairing or replacing, as hereinafter provided, at its option any product found to Dixon's satisfaction to be defective upon examination by it, provided that such product shall be returned for inspection to Dixon's factory within three (3) months after discovery of the defect. The repair or replacement of defective products will be made without charge for parts or labor. This warranty shall not apply to: (a) parts or products not manufactured by Dixon, the warranty of such items being limited to the actual warranty extended to Dixon by its supplier; (b) any product that has been subject to abuse, negligence, accident, or misapplication; (c) any product altered or repaired by others than Dixon; and (d) to normal maintenance services and the replacement of service items (such as washers, gaskets, and lubricants) made in connection with such services. To the extent permitted by law, this limited warranty shall extend only to the buyer and any other person reasonably expected to use or consume the goods who is injured in person by any breach of the warranty. No action may be brought against Dixon for an alleged breach of warranty unless such action is instituted within one (1) year from the date the cause of action accrues. This limited warranty shall be construed and enforced to the fullest extent allowable by applicable law.

Other than the obligation of Dixon set forth herein, Dixon disclaims all warranties, express or implied, including but not limited to any implied warranties of merchantability or fitness for a particular purpose, and any other obligation or liability. The foregoing constitutes Dixon's sole obligation with respect to damages, whether direct, incidental, or consequential, resulting from the use or performance of the product.

Some products and sizes may be discontinued when stock is depleted or may require a minimum quantity for ordering.

About This Brochure and Our Products

This brochure is intended as a product offering. It is not a user or technical manual. Information in this brochure is subject to change without notice. We may modify product design and specification without notice and without any obligation to modify or substitute products previously purchased. All users and distributors of products sold through this brochure are strongly encouraged to contact Dixon with questions on use, compatibilities, coupling procedures, and life of product. Our full-time engineering and test staff are always available to recommend uses and to assist distributors and users with questions.



Safety



Safety logos, which appear throughout our brochure, are used as a reminder that the user should carefully review for the appropriateness of the product for the media, application, and environment in which it will be used.

NOTE: Because of the health hazards associated with contamination and lead content in drinking water systems, Dixon couplings, unless otherwise specifically approved, are not recommended for potable water service and should not be used in applications where drinking water will contact the wetted surfaces of the coupling.

All Dixon products are shipped in cartons with the following warning:

"WARNING: This product contains lead, a chemical known to the State of California to cause cancer and birth defects or other reproductive harm."

Trademarks

Delrin® and Zytel® are registered trademarks of DuPont Nemours and Company.

Kalrez® is a registered trademark of DuPont Dow Elastomers.

All other trademarks appearing in the Dixon illustrated price list are the property of their respective owners.

Copyright

Copyright © 2023 by Dixon Valve and Coupling, LLC

All rights reserved. This book is copyrighted material. Use, reproduction or copying of it by anyone other than Dixon® is strictly forbidden without its express written consent.

NOTE: Reasonable care has been taken in preparing this brochure. Dixon Valve & Coupling Company, LLC reserves the right to make corrections.

