



---

Table of Contents

**Swivel Joint Overview** ..... 3-7

    New products ..... 4

    Operations / Service ..... 5

    Swivel color and etching identification ..... 6

    Swivel joint styles ..... 7

**O-Ring Swivel Joints** ..... 8-21

    Overview ..... 8

    Exploded view / Part number key ..... 8

    Configurations / Parts ..... 9-19

    Rebuild kits ..... 20

    Seal replacement ..... 21

**V-Ring Swivel Joints** ..... 22-32

    Overview ..... 22

    Exploded view / Part number key ..... 22

    Configurations / Parts ..... 23-30

    Rebuild kits ..... 31

    Seal replacement ..... 32

**Cap Seal Swivel Joints** ..... 33-39

    Overview / Exploded view ..... 33

    Part number key ..... 34

    Configurations / Parts ..... 34-37

    Seal replacement ..... 38-39

**Split Flange Swivel Joints** ..... 40-48

    Overview ..... 40

    Exploded view / Part number key ..... 40

    Configurations / Parts ..... 41-47

    Components ..... 47

    Seal replacement ..... 48

**High Capacity Split Flange Swivel Joints** ..... 49-57

    Overview ..... 49

    Exploded view / Part number key ..... 49

    Configurations / Parts ..... 50-55

    Components ..... 56

    Seal Replacement ..... 57

**Loading Arms** ..... 58-61

    Overview ..... 58

    Configurations / Parts ..... 58-59

    Base swivels with counterbalance ..... 60

    Loading arm swivels ..... 61

## Table of Contents

|  |              |
|--|--------------|
| <b>Swivel Joint Accessories</b> .....                            | <b>62-67</b> |
| Flanges / Gaskets .....  | 62-64        |
| Pipe fittings, half couplings, grease fittings, set screws ..... | 65           |
| Handle kits.....   | 66           |
| Thread sealant.....  | 66           |
| Joint sealant gasket materials.....                              | 66           |
| PTFE tape .....  | 67           |
| <b>Safety &amp; Technical</b> .....                              | <b>68-71</b> |
| Bolt tightening sequence.....                                    | 68           |
| Flange diagrams.....   | 68           |
| ANSI flange dimensions .....                                     | 69           |
| Pressure rating chart .....                                      | 70           |
| Limited warranty / Safety .....                                  | 71           |

## Swivel Joints Overview

### Applications

- Used wherever a leak-proof swivel connection is needed in pipelines or in combination with hoses to eliminate hose twisting.
- Ideal for a wide range of industries including petroleum, petrochemical, refining, mining, distilling, paint, farm irrigation and fertilizing, wastewater treatment plants, and food and beverage process equipment. Dixon® swivel joints are commonly used in blending plants, drum filling applications, fluid and dry bulk transfer, vacuum trucks, oil and gas trucks and water trucks. Larger swivels can be found in the steel industry, marine bulk transfer, and many more applications.

### Features

- Full 360° rotational movement
- 100% full penetration weld
- Wide spacing between dual ball bearing raceways ensures greater load bearing capacity
- Precision-machined design ensures alignment and years of trouble-free service
- O-ring dust seal protects the ball races and seals chamber from outside elements
- Radius elbow design ensures a smooth flow path
- All swivels undergo rigorous hydrostatic testing prior to shipment to ensure performance and reliability, with the exception of weld end swivels, which are prepared for customer-specific testing after installation.

### Additional Options

- End configurations: male NPT, female NPT, 150# flange, TTMA flange, grooved, weld end, and others upon request.
- Seal options: nitrile rubber, FKM, PTFE, EPDM, FDA nitrile rubber, and low temperature FKM
- Ball bearing materials: carbon steel, 440 stainless steel, and 316 stainless steel
- Grease materials: Lithium, FDA approved/food grade, silicone, and low temperature grease
- Swivels that include oxygen, steam, submerged, or vacuum service can be specifically designed for unique applications (special order)
- Swivel Joint Types: O-ring, V-ring, Split Flange, Cap Seal, and High Capacity Split Flange
- Locking mechanism for split flange swivels
- Epoxy paint
- Re-build kits available
- Custom swivel options available; contact Dixon at 877.963.4966

Swivel configurator available at [canada.dixonvalve.com](http://canada.dixonvalve.com)

New Products

14"-24" Cap Seal Swivel Joints



Pg. 33

14" V-Ring Swivel Joints



Pg. 22

Aluminum Nose Pieces for Split Flange Swivel Joints



Pg. 40

High Capacity Split Flange Swivel Joints



Pg. 49

4" Ductile Iron O-Ring Style Swivel Joints



Pg. 9

Total Rebuild Kits for O-Ring Swivels



Pg. 20

Total Rebuild Kits for V-Ring Swivels



Pg. 31

TTMA Gasket Kits



Pg. 62

150 lb. Flange Gasket Kits



Pg. 63



## Operation / Service

Dixon® swivels are recommended for use at the following maximum Non-Shock Cold Working Pressures (NSCWP) provided in **PSI** at ambient temperature **70°F (21°C)** for 1" – 24" sizes:

- See pressure rating chart on pg. 70 
- When using flanged ends, the pressure rating will be reduced to coincide with that of the flange being used. Carbon steel and stainless steel 150# flanges are recommended for use at **275 PSI** maximum and 300# flanges at **740 PSI** at ambient temperature **70°F (21°C)**.
- TTMA flanges are recommended for use to **150 PSI** maximum at ambient temperature **70°F (21°C)**.
- Lubrication should be performed periodically, depending on service and operation conditions. Biannually is normally sufficient.
- All dimensions are approximate. Where critical, consult Dixon.

## Use with Hose

When using swivel joints to compensate for hose twist (e.g., Style 20 or Style 60), careful consideration is needed. The hose must be stiff enough to generate sufficient torque to activate the swivel before kinking occurs.

In many cases, lateral movement-induced twist can be resolved with a swivel joint (e.g., Style 40 or Style 30). If not, hose swivels may offer a solution. These non-ball bearing designs require less torque for rotation but are not intended for load-bearing applications.

It's important to note that some hoses, such as many metal hoses, may not produce enough torque to rotate even a hose swivel. On the other hand, stiffer hoses, like many armored hoses, can easily turn most swivels.

## Pricing

Pricing is available upon request. Please contact Dixon for assistance with pricing and selecting the right equipment for your specific application.

Each swivel joint is custom-built to order, so returns are generally not accepted. However, return requests will be considered on a case-by-case basis. Approved returns will be subject to a restocking fee of 15%, along with any additional costs incurred.

## S.T.A.M.P.E.D.

**When fabricating and specifying assemblies ask the following questions:**

- Size:** What is the I.D. (inside diameter)? What is the O.D. (outside diameter)? What is the overall length of the assembly required?
- Temperature:** What is the temperature range of the media (product) that is flowing through the assembly? What is the temperature range of the environment that surrounds the outside of the assembly?
- Application:** How is the assembly actually being used? Is it a pressure application? Is it a vacuum (suction) application? Is it a gravity flow application? Are there any special requirements that the assembly is expected to perform? Is the assembly being used in a horizontal or vertical position? Are there any pulsations or vibrations acting on the assembly?
- Media:** What is the media/material that is flowing through the assembly? Being specific is critical. Check for: Abrasive materials, chemical compatibility, etc.
- Pressure:** What is the maximum pressure including surges (or, maximum vacuum) that this assembly will be subjected to? Always rate the maximum working pressure of your assembly by the lowest rated component in the system.
- Ends:** What end connection has been requested by the user? Are they the proper fittings for the application?
- Dixon:** Be Safe: Any questions on application, use, or assembly, call 877.963.4966.

## Color Identification

Color identification is important in manufacturing processes because it aids in quickly distinguishing differences between parts, materials and assembly stages, thereby reducing errors and improving efficiency. At times color identification can also clarify the type of media that is flowing through a piping system. However, for the standard Dixon Swivel Joints the color or finish aids in identifying the material and seal design.

### O-Ring



Aluminum



Brass



Ductile Iron

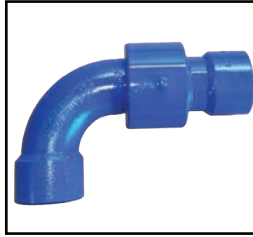

Carbon Steel

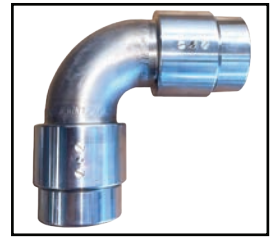

Stainless Steel

### V-Ring / Cap Seal



Aluminum



Carbon Steel



Stainless Steel

### Split Flange / High Capacity



Aluminum



Carbon Steel



Stainless Steel

## Part Number Etching Identification

Dixon Swivel Joints are etched with their unique part number for accurate identification. This practice supports quality control and inventory management. Additionally, the etched identification helps simplify maintenance and replacement, as it allows quick reference to specific parts in technical documentation and service records.



### Swivel Joint Styles

#### Single Plane



style 20



style 30

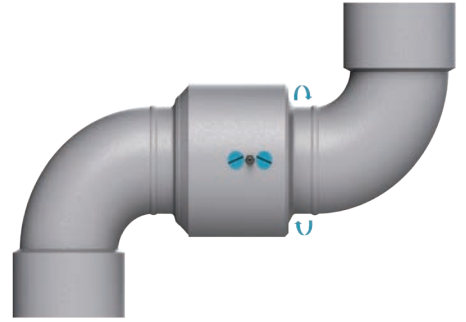

style 40

#### Double Plane

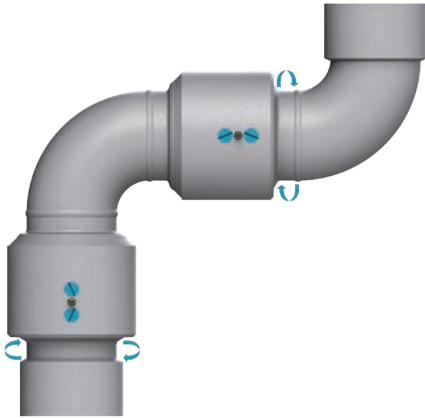

style 50



style 60

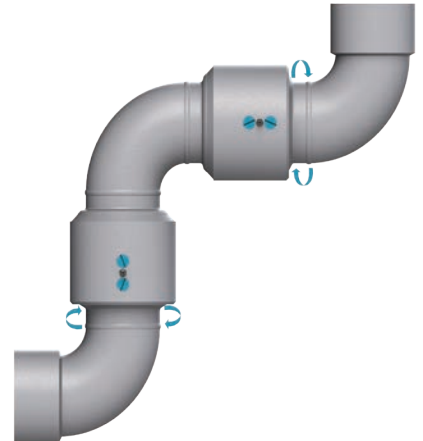

style 70

#### Triple Plane

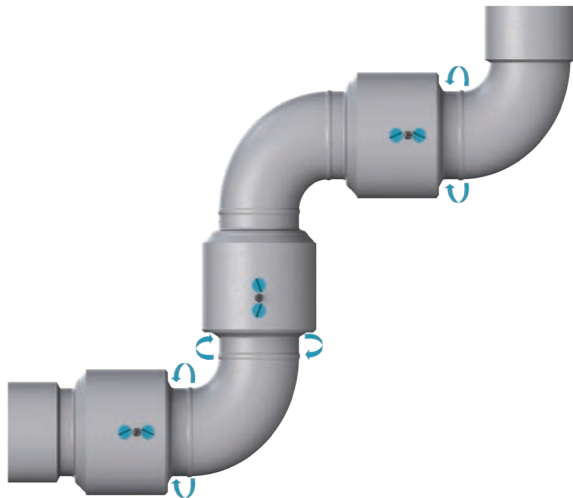

style 80

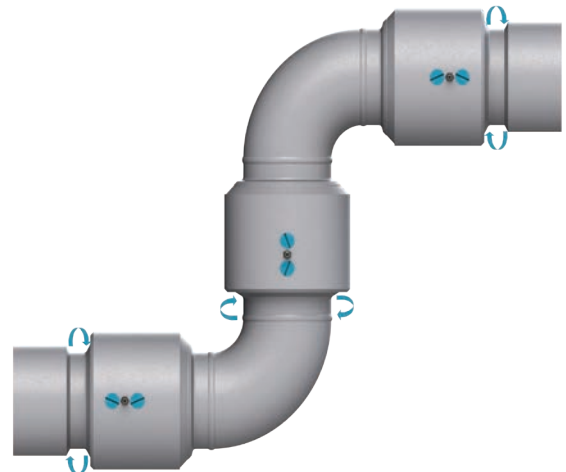

style 10

## O-Ring Swivel Joints

### Applications

- Commonly used in tote/drum loading, loading arms, hose and steam, water supply lines, tank trucks, compressed air, asphalt, irrigation, suction and vacuum, petroleum, and mining.

### Sizes

- 1" - 4"

### Features

- O-ring pressure seal ensures a leak-proof seal and smooth rotation with lower torque
- Smooth moving seal for high-volume drum and tote loading
- Available working pressure ratings up to **1,000 PSI**, based on material and end connections
- Available end connections include: 150 lbs. and 300 lbs. flanges, FNPT, MNPT, butt weld, TTMA, and others upon request
- End connections and materials offered may vary based on size, contact Dixon® for details

### Materials

- Available materials include carbon steel, 316L stainless steel, aluminum, brass, and ductile iron

### Bill of Materials

1. Body
2. Sleeve
3. Ball bearings
4. Grease fitting
5. Ball retainer screws
6. O-ring (dust seal)
7. O-ring (pressure seal)

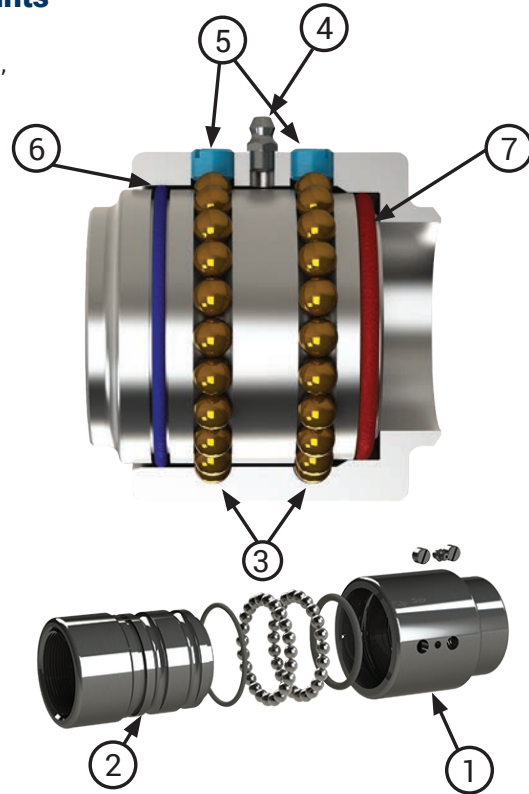

### O-Ring Swivel Joint Numbering System

| 2            | 20     | F              | x | F              | OC                              | 0                      | 0                      | 0               | 0                       | 0                   |
|--------------|--------|----------------|---|----------------|---------------------------------|------------------------|------------------------|-----------------|-------------------------|---------------------|
| Sizes Inches | Style* | End Connection | x | End Connection | Material                        | Pressure Seal          | Dust Seal              | Retainers       | Ball Bearings           | Grease              |
| 1 = 1"       | 20     | F (FNPT)       | x | F (FNPT)       | AL = aluminum                   | 0 = nitrile rubber     | 0 = nitrile rubber     | 0 = no retainer | 0 = carbon steel        | 0 = lithium         |
| 125 = 1-1/4" | 30     | W (weld)       | x | W (weld)       | BR = brass                      | 1 = FKM                | 1 = FKM                |                 | 1 = 440 stainless steel | 1 = food grade      |
| 150 = 1-1/2" | 40     | FG (150#)      | x | FG (150#)      | MI = ductile iron               | 2 = PTFE               |                        |                 | 2 = 316 stainless steel | 2 = silicone        |
| 2 = 2"       | 50     | PF (300#)      | x | PF (300#)      | OC = O-ring carbon steel        | 3 = EPDM               | 3 = EPDM               |                 |                         | 3 = Tribolube       |
| 3 = 3"       | 60     | TF (TTMA)      | x | TF (TTMA)      | OS = O-ring 316 stainless steel | 4 = FDA nitrile rubber | 4 = FDA nitrile rubber |                 |                         | 4 = low temperature |
| 4 = 4"       | 70     | BP (BSPP)      | x | BP (BSPP)      |                                 | 5 = No seal            | 5 = No seal            |                 |                         | 5 = no grease       |
|              | 80     | BT (BSPT)      | x | BT (BSPT)      |                                 | A = Low Temp FKM       |                        |                 |                         |                     |
|              | 10     | G (groove)     | x | G (groove)     |                                 |                        |                        |                 |                         |                     |
|              |        | M (MNPT)       | x | M (MNPT)       |                                 |                        |                        |                 |                         |                     |

\*If ordering a handle, the zero would be replaced by H or B. Use "H" for a heavy-duty D-style shovel handle.

NOTE: Other end connections or seals are available upon request.

- Brass O-ring: 1-1/2" - 3"
- Ductile iron O-ring: 1-1/2" - 4"
- Standard grease fitting without ball check on all O-ring Swivel Joint materials except 316 stainless steel. Ask for check ball if required. 316 SS O-ring Swivel Joints include SS grease fitting with ball check.
- Dixon® does not offer 4" O-ring configuration for stainless steel material.



**O-Ring Style 20 - Weld x Weld**

| Size   | Part #   | Material             | Weight (lbs) | Dimension A |
|--------|----------|----------------------|--------------|-------------|
| 1"     | 120WXW   | OC - carbon steel    | 3            | 2-7/8"      |
|        |          | OS - stainless steel | 3            |             |
| 1-1/2" | 15020WXW | OC - carbon steel    | 3            | 3-3/16"     |
|        |          | OS - stainless steel | 3            |             |
|        |          | AL - aluminum        | 1            | 3-13/16"    |
| 2"     | 220WXW   | OC - carbon steel    | 5            | 3-9/16"     |
|        |          | OS - stainless steel | 5            |             |
|        |          | AL - aluminum        | 3            | 5-3/8"      |
| 3"     | 320WXW   | OC - carbon steel    | 7            | 4-1/8"      |
|        |          | OS - stainless steel | 7            |             |
|        |          | AL - aluminum        | 4            | 5-11/16"    |
| 4"     | 420WXW   | OC - carbon steel    | 21           | 6"          |
|        |          | AL - aluminum        | 7            | 7-5/16"     |

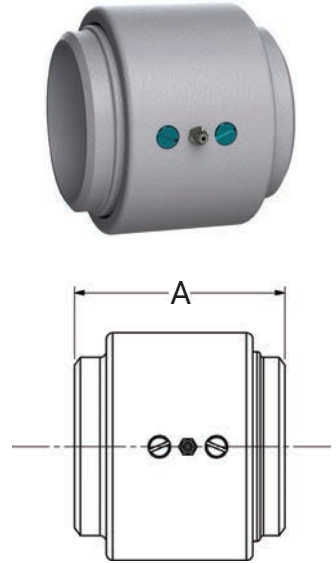

**O-Ring Style 20 - FNPT x FNPT**

| Size   | Part #   | Material             | Weight (lbs) | Dimension A |
|--------|----------|----------------------|--------------|-------------|
| 1"     | 120FXF   | OC - carbon steel    | 3            | 3-15/16"    |
|        |          | OS - stainless steel | 3            |             |
|        |          | AL - aluminum        | 1            |             |
| 1-1/4" | 12520FXF | AL - aluminum        | 1            | 3-31/32"    |
| 1-1/2" | 15020FXF | OC - carbon steel    | 4            | 4"          |
|        |          | OS - stainless steel | 4            |             |
|        |          | AL - aluminum        | 1            |             |
|        |          | BR - brass           | 4            |             |
|        |          | MI - ductile iron    | 4            |             |
| 2"     | 220FXF   | OC - carbon steel    | 6            | 5-9/16"     |
|        |          | OS - stainless steel | 7            |             |
|        |          | AL - aluminum        | 4            |             |
|        |          | BR - brass           | 9            |             |
|        |          | MI - ductile iron    | 8            |             |
| 3"     | 320FXF   | OC - carbon steel    | 9            | 5-7/8"      |
|        |          | OS - stainless steel | 9            |             |
|        |          | AL - aluminum        | 4            | 5-29/32"    |
|        |          | BR - brass           | 11           |             |
| 4"     | 420FXF   | OC - carbon steel    | 34           | 10-3/4"     |
|        |          | AL - aluminum        | 7            | 7-5/8"      |
|        |          | MI - ductile Iron    | 18           |             |

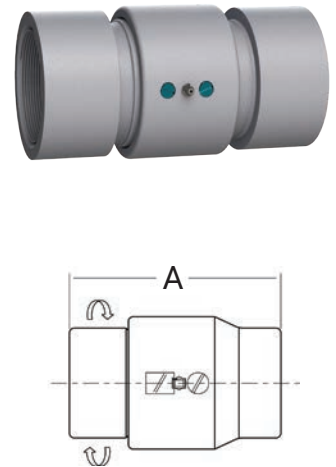

**O-Ring Style 20 - 150# Flange x 150# Flange**

| Size   | Part #   | Material             | Weight (lbs) | Dimension A |
|--------|----------|----------------------|--------------|-------------|
| 1"     | 120FGXFG | OS - stainless steel | 8            | 7-9/32"     |
|        |          | OC - carbon steel    |              |             |
| 1-1/2" | 1520FGFG | OC - carbon steel    | 12           | 8-1/16"     |
|        |          | OS - stainless steel | 12           |             |
|        |          | AL - aluminum        | 4            | 8-11/16"    |
| 2"     | 220FGXFG | OC - carbon steel    | 17           | 8-17/32"    |
|        |          | OS - stainless steel | 17           |             |
|        |          | AL - aluminum        | 8            | 10-3/8"     |
| 3"     | 320FGXFG | OC - carbon steel    | 31           | 9-5/8"      |
|        |          | OS - stainless steel | 31           |             |
|        |          | AL - aluminum        | 10           | 11-5/32"    |
| 4"     | 420FGXFG | OC - carbon steel    | 51           | 12"         |
|        |          | AL - aluminum        | 13           | 13-5/16"    |

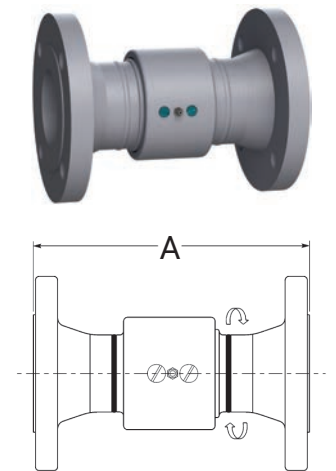

O-Ring Style 30 - FNPT x FNPT

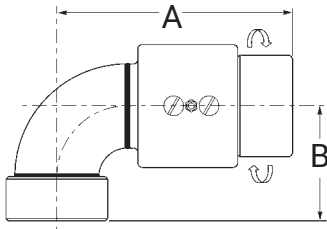

| Size   | Part #   | Material             | Weight (lbs) | Dimensions |          |
|--------|----------|----------------------|--------------|------------|----------|
|        |          |                      |              | A          | B        |
| 1"     | 130FXF   | OC - carbon steel    | 4            | 4-13/32"   | 2-3/16"  |
|        |          | OS - stainless steel | 3            | 5-29/32"   | 2-11/16" |
| 1-1/2" | 15030FXF | OC - carbon steel    | 5            | 5-7/16"    | 3-15/32" |
|        |          | OS - stainless steel | 6            |            |          |
|        |          | AL - aluminum        | 2            | 4-11/16"   | 3"       |
|        |          | BR - brass           | 5            |            |          |
|        |          | MI - ductile iron    | 5            |            |          |
| 2"     | 230FXF   | OC - carbon steel    | 8            | 6-21/32"   | 3-1/4"   |
|        |          | OS - stainless steel | 6            |            |          |
|        |          | AL - aluminum        | 4            | 6-3/16"    | 2-7/8"   |
|        |          | BR - brass           | 10           |            |          |
|        |          | MI - ductile iron    | 9            |            |          |
| 3"     | 330FXF   | OC - carbon steel    | 13           | 8-9/64"    | 4-13/16" |
|        |          | OS - stainless steel | 13           |            |          |
|        |          | AL - aluminum        | 5            | 7-1/16"    | 3-7/8"   |
|        |          | BR - brass           | 15           |            |          |
|        |          | MI - ductile iron    | 13           |            |          |
| 4"     | 430FXF   | OC - carbon steel    | 40           | 12-3/8"    | 6-3/8"   |
|        |          | AL - aluminum        | 9            | 9-1/8"     | 4-3/4"   |

O-Ring Style 30 - 150# Flange x 150# Flange

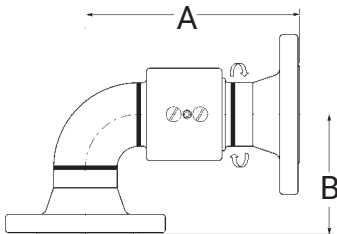

| Size   | Part #   | Material             | Weight (lbs) | Dimensions |          |
|--------|----------|----------------------|--------------|------------|----------|
|        |          |                      |              | A          | B        |
| 1"     | 130FGXFG | OC - carbon steel    | 8            | 6-3/32"    | 3-3/16"  |
|        |          | OS - stainless steel | 8            | 6-19/32"   | 3-11/16" |
| 1-1/2" | 1530FGFG | OC - carbon steel    | 12           | 7-7/8"     | 4-11/16" |
|        |          | OS - stainless steel | 12           |            |          |
|        |          | AL - aluminum        | 4            | 7-1/32"    | 5-11/32" |
| 2"     | 230FGXFG | OC - carbon steel    | 20           | 8-1/32"    | 4-1/2"   |
|        |          | OS - stainless steel | 20           |            |          |
|        |          | AL - aluminum        | 8            | 8-5/8"     | 5-9/32"  |
| 3"     | 330FGXFG | OC - carbon steel    | 33           | 9-7/8"     | 5-3/4"   |
|        |          | OS - stainless steel | 33           |            |          |
|        |          | AL - aluminum        | 13           | 9-11/16"   | 6-15/32" |
| 4"     | 430FGXFG | OC - carbon steel    | 57           | 13"        | 7"       |
|        |          | AL - aluminum        | 14           | 11-31/32"  | 7-19/32" |

**O-Ring Style 30 - TTMA Flange x TTMA Flange**

| Size | Part #   | Material             | Weight (lbs) | Dimensions |          |
|------|----------|----------------------|--------------|------------|----------|
|      |          |                      |              | A          | B        |
| 2"   | 230TFXTF | OC - carbon steel    | 8            | 5-5/8"     | 5-1/8"   |
|      |          | OS - stainless steel | 7            |            |          |
|      |          | AL - aluminum        | 5            | 5-5/8"     | 5-1/8"   |
| 3"   | 330TFXTF | OC - carbon steel    | 14           | 8-1/2"     | 4-3/8"   |
|      |          | OS - stainless steel | 15           |            |          |
|      |          | AL - aluminum        | 6            | 7-3/4"     | 4-15/16" |
| 4"   | 430TFXTF | OC - carbon steel    | 30           | 10-1/4"    | 4-1/4"   |
|      |          | AL - aluminum        | 12           | 8-7/8"     | 5-17/32" |

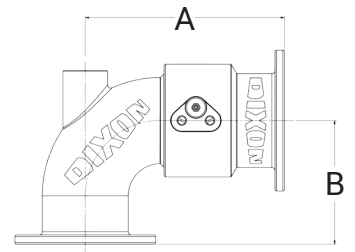

**O-Ring Style 30 - TTMA Flange x TTMA Flange with D-Handle**

| Size | Part #   | Material             | Weight (lbs) | Dimensions |          |
|------|----------|----------------------|--------------|------------|----------|
|      |          |                      |              | A          | B        |
| 2"   | 23HTFXTF | OC - carbon steel    | 10           | 5-5/8"     | 5-1/8"   |
|      |          | OS - stainless steel | 9            |            |          |
|      |          | AL - aluminum        | 7            | 5-5/8"     | 5-1/8"   |
| 3"   | 33HTFXTF | OC - carbon steel    | 17           | 8-1/2"     | 4-3/8"   |
|      |          | OS - stainless steel | 17           |            |          |
|      |          | AL - aluminum        | 8            | 7-3/4"     | 4-15/16" |
| 4"   | 43HTFXTF | OC - carbon steel    | 33           | 10-1/4"    | 4-1/4"   |
|      |          | AL - aluminum        | 14           | 8-7/8"     | 5-17/32" |

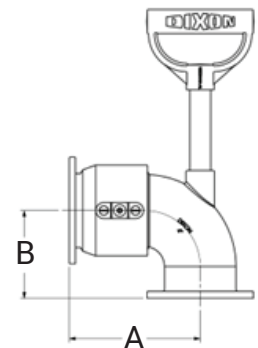

**O-Ring Style 40 - FNPT x FNPT**

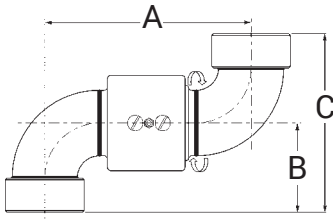

| Size   | Part #   | Material             | Weight (lbs) | Dimensions |          |          |
|--------|----------|----------------------|--------------|------------|----------|----------|
|        |          |                      |              | A          | B        | C        |
| 1"     | 140FXF   | OC - carbon steel    | 4            | 4-59/64"   | 2-3/16"  | 4-3/8"   |
|        |          | OS - stainless steel | 4            | 5-59/64"   | 2-11/16" | 5-3/8"   |
| 1-1/2" | 15040FXF | OC - carbon steel    | 7            | 7-11/16"   | 3-15/32" | 6-15/16" |
|        |          | OS - stainless steel | 7            |            |          |          |
|        |          | AL - aluminum        | 2            | 6-1/8"     | 3"       | 6"       |
|        |          | BR - brass           | 7            |            |          |          |
|        |          | MI - ductile iron    | 6            |            |          |          |
| 2"     | 240FXF   | OC - carbon steel    | 9            | 7-17/32"   | 3-1/4"   | 6-1/2"   |
|        |          | OS - stainless steel | 9            |            |          |          |
|        |          | AL - aluminum        | 5            | 6-11/16"   | 2-7/8"   | 5-3/4"   |
|        |          | BR - brass           | 11           |            |          |          |
|        |          | MI - ductile iron    | 9            |            |          |          |
| 3"     | 340FXF   | OC - carbon steel    | 18           | 10-1/8"    | 4-13/16" | 9-5/8"   |
|        |          | OS - stainless steel | 18           |            |          |          |
|        |          | AL - aluminum        | 6            | 8-1/4"     | 3-7/8"   | 7-3/4"   |
|        |          | BR - brass           | 18           |            |          |          |
|        |          | MI - ductile iron    | 15           |            |          |          |
| 4"     | 440FXF   | OC - carbon steel    | 45           | 14"        | 6-3/8"   | 12-3/4"  |
|        |          | AL - aluminum        | 10           | 10-5/8"    | 4-3/4"   | 9-1/2"   |

**O-Ring Style 40 - 150# Flange x 150# Flange**

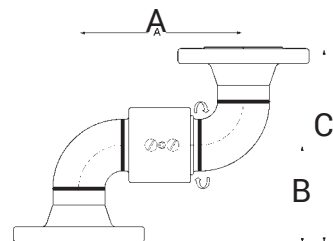

| Size   | Part #     | Material             | Weight (lbs) | Dimensions |          |          |
|--------|------------|----------------------|--------------|------------|----------|----------|
|        |            |                      |              | A          | B        | C        |
| 1"     | 140FGXFG   | OC - carbon steel    | 9            | 4-59/64"   | 3-3/16"  | 6-3/8"   |
|        |            | OS - stainless steel | 9            | 5-59/64"   | 3-11/16" | 7-3/8"   |
| 1-1/2" | 15040FGXFG | OC - carbon steel    | 13           | 7-11/16"   | 4-11/16" | 9-3/8"   |
|        |            | OS - stainless steel | 13           |            |          |          |
|        |            | AL - aluminum        | 4            | 6-1/8"     | 5-11/32" | 5-11/16" |
| 2"     | 240FGXFG   | OC - carbon steel    | 21           | 7-17/32"   | 4-1/2"   | 9"       |
|        |            | OS - stainless steel | 21           |            |          |          |
|        |            | AL - aluminum        | 8            | 6-11/16"   | 5-9/32"  | 10-9/16" |
| 3"     | 340FGXFG   | OC - carbon steel    | 40           | 10-1/8"    | 5-3/4"   | 11-1/2"  |
|        |            | OS - stainless steel | 40           |            |          |          |
|        |            | AL - aluminum        | 11           | 8-1/4"     | 6-5/8"   | 13-1/4"  |
| 4"     | 440FGXFG   | OC - carbon steel    | 62           | 14"        | 7"       | 14"      |
|        |            | AL - aluminum        | 16           | 10-5/8"    | 7-9/16"  | 15-1/8"  |

**O-Ring Style 40 - TTMA Flange x TTMA Flange**

| Size | Part #   | Material             | Weight (lbs) | Dimensions |          |         |
|------|----------|----------------------|--------------|------------|----------|---------|
|      |          |                      |              | A          | B        | C       |
| 2"   | 240TFXTF | OC - carbon steel    | 8            | 7-17/32"   | 5-1/8"   | 10-1/4" |
|      |          | OS - stainless steel | 8            |            |          |         |
|      |          | AL - aluminum        | 4            | 6-11/16"   | 5-1/8"   | 10-1/4" |
| 3"   | 340TFXTF | OC - carbon steel    | 17           | 10-1/8"    | 4-3/8"   | 8-3/4"  |
|      |          | OS - stainless steel | 18           |            |          |         |
|      |          | AL - aluminum        | 7            | 9-9/64"    | 4-15/16" | 9-7/8"  |
| 4"   | 440TFXTF | OC - carbon steel    | 36           | 14"        | 4-1/4"   | 8-1/2"  |
|      |          | AL - aluminum        | 17           | 10-5/8"    | 6-9/16"  | 13-1/8" |

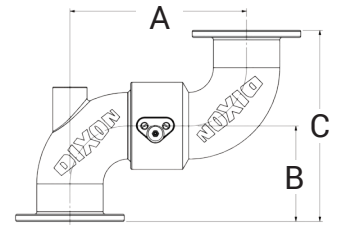

**O-Ring Style 40 - TTMA Flange x TTMA Flange with D-handle**

| Size | Part #   | Material             | Weight (lbs) | Dimensions |          |         |
|------|----------|----------------------|--------------|------------|----------|---------|
|      |          |                      |              | A          | B        | C       |
| 2"   | 24HTFXTF | OC - carbon steel    | 10           | 7-17/32"   | 5-1/8"   | 10-1/4" |
|      |          | OS - stainless steel | 10           |            |          |         |
|      |          | AL - aluminum        | 6            | 6-11/16"   | 5-1/8"   | 10-1/4" |
| 3"   | 34HTFXTF | OC - carbon steel    | 18           | 10-1/8"    | 4-3/8"   | 8-3/4"  |
|      |          | OS - stainless steel | 18           |            |          |         |
|      |          | AL - aluminum        | 9            | 9-9/64"    | 4-15/16" | 9-7/8"  |
| 4"   | 44HTFXTF | OC - carbon steel    | 39           | 14"        | 4-1/4"   | 8-1/2"  |
|      |          | AL - aluminum        | 19           | 10-5/8"    | 6-9/16"  | 13-1/8" |

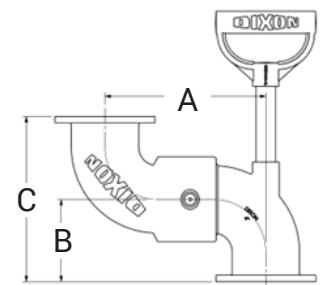



O-Ring Style 50 - FNPT x FNPT

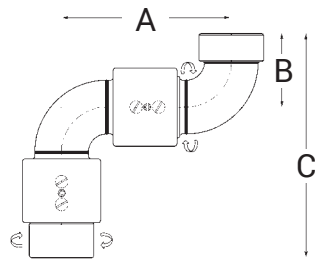

| Size              | Part #   | Material             | Weight (lbs) | Dimensions |          |           |
|-------------------|----------|----------------------|--------------|------------|----------|-----------|
|                   |          |                      |              | A          | B        | C         |
| 1"                | 150FXF   | OC - carbon steel    | 7            | 4-59/64"   | 2-3/16"  | 6-3/32"   |
|                   |          | OS - stainless steel | 7            | 5-59/64"   | 2-11/16" | 7-19/32"  |
| 1-1/2"            | 15050FXF | OC - carbon steel    | 9            | 7-11/16"   | 3-15/32" | 8-29/32"  |
|                   |          | OS - stainless steel | 9            |            |          |           |
|                   |          | AL - aluminum        | 3            | 6-1/8"     | 3"       | 7-11/16"  |
| 2"                | 250FXF   | OC - carbon steel    | 14           | 7-17/32"   | 3-1/4"   | 9-29/32"  |
|                   |          | OS - stainless steel | 14           |            |          |           |
|                   |          | AL - aluminum        | 8            | 6-11/16"   | 2-7/8"   | 9-1/16"   |
|                   |          | BR - brass           | 15           |            |          |           |
| MI - ductile iron | 13       |                      |              |            |          |           |
| 3"                | 350FXF   | OC - carbon steel    | 22           | 10-1/8"    | 4-13/16" | 12-61/64" |
|                   |          | OS - stainless steel | 22           |            |          |           |
|                   |          | AL - aluminum        | 9            | 8-1/4"     | 3-7/8"   | 10-29/32" |
|                   |          | MI - ductile iron    | 22           |            |          |           |
| 4"                | 450FXF   | OC - carbon steel    | 67           | 14"        | 6-3/8"   | 18-3/4"   |
|                   |          | AL - aluminum        | 15           | 10-5/8"    | 4-3/4"   | 13-7/8"   |

O-Ring Style 50 - 150# Flange x 150# Flange

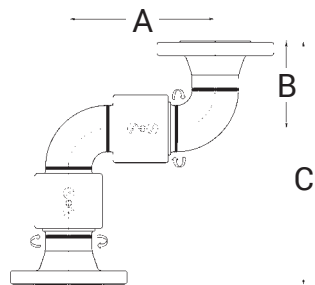

| Size   | Part #   | Material             | Weight (lbs) | Dimensions |          |           |
|--------|----------|----------------------|--------------|------------|----------|-----------|
|        |          |                      |              | A          | B        | C         |
| 1"     | 150FGXFG | OC - carbon steel    | 11           | 4-59/64"   | 3-3/16"  | 9-19/64"  |
|        |          | OS - stainless steel | 11           | 5-59/64"   | 3-11/16" | 10-19/64" |
| 1-1/2" | 1550FGFG | OC - carbon steel    | 14           | 7-11/16"   | 4-11/16" | 12-9/16"  |
|        |          | OS - stainless steel | 14           |            |          |           |
|        |          | AL - aluminum        | 6            | 6-1/8"     | 5-11/32" | 12-3/8"   |
| 2"     | 250FGXFG | OC - carbon steel    | 23           | 7-17/32"   | 4-1/2"   | 12-17/32" |
|        |          | OS - stainless steel | 23           |            |          |           |
|        |          | AL - aluminum        | 12           | 6-11/16"   | 5-9/32"  | 13-29/32" |
| 3"     | 350FGXFG | OC - carbon steel    | 38           | 10-1/8"    | 5-3/4"   | 15-5/8"   |
|        |          | OS - stainless steel | 38           |            |          |           |
|        |          | AL - aluminum        | 17           | 8-1/4"     | 6-15/32" | 16-3/32"  |
| 4"     | 450FGXFG | OC - carbon steel    | 83           | 10-5/8"    | 7-19/32" | 19-9/16"  |
|        |          | AL - aluminum        | 26           | 10-5/8"    | 7-19/32" | 19-9/16"  |

O-Ring Style 50 - TTMA Flange x TTMA Flange

| Size | Part #   | Material             | Weight (lbs) | Dimension A | Dimension B | Dimension C |
|------|----------|----------------------|--------------|-------------|-------------|-------------|
| 2"   | 250TFXTF | OC - carbon steel    | 13           | 7-17/32"    | 2-3/16"     | 9-13/32"    |
|      |          | OS - stainless steel | 13           |             |             |             |
|      |          | AL - aluminum        | 9            |             |             |             |
| 3"   | 350TFXTF | OC - carbon steel    | 24           | 10-1/8"     | 3-1/8"      | 12"         |
|      |          | OS - stainless steel | 23           |             |             |             |
|      |          | AL - aluminum        | 9            |             |             |             |
| 4"   | 450TFXTF | OC - carbon steel    | 57           | 14"         | 4-1/4"      | 14-1/2"     |
|      |          | AL - aluminum        | 16           | 10-5/8"     | 5-1/2"      | 14-3/16"    |

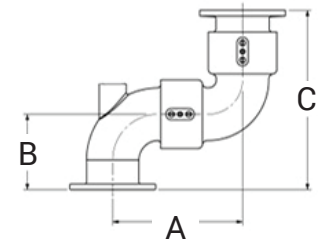

O-Ring Style 50 - TTMA Flange x TTMA Flange with D-handle

| Size | Part #   | Material             | Weight (lbs) | Dimension A | Dimension B | Dimension C |
|------|----------|----------------------|--------------|-------------|-------------|-------------|
| 2"   | 25HTFXTF | OC - carbon steel    | 17           | 7-17/32"    | 2-3/16"     | 9-13/32"    |
|      |          | OS - stainless steel | 17           |             |             |             |
|      |          | AL - aluminum        | 11           |             |             |             |
| 3"   | 35HTFXTF | OC - carbon steel    | 27           | 10-1/8"     | 3-1/8"      | 12"         |
|      |          | OS - stainless steel | 26           |             |             |             |
|      |          | AL - aluminum        | 11           |             |             |             |
| 4"   | 45HTFXTF | OC - carbon steel    | 60           | 14"         | 4-1/4"      | 14-1/2"     |
|      |          | AL - aluminum        | 19           | 10-5/8"     | 5-1/2"      | 14-3/16"    |

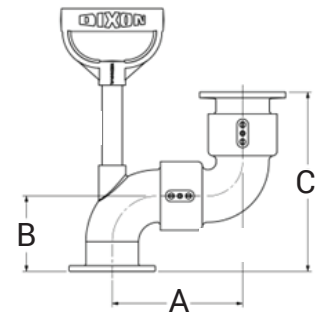

O-Ring Style 60 - FNPT x FNPT

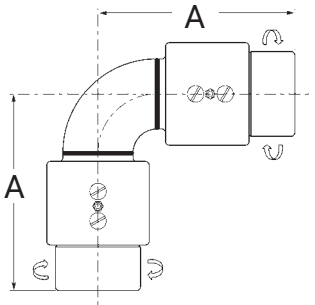

| Size   | Part #   | Material             | Weight (lbs) | Dimension A |
|--------|----------|----------------------|--------------|-------------|
| 1"     | 160FXF   | OC - carbon steel    | 6            | 4-13/32"    |
|        |          | OS - stainless steel | 6            | 4-29/32"    |
| 1-1/2" | 15060FXF | OC - carbon steel    | 9            | 5-7/16"     |
|        |          | OS - stainless steel | 9            |             |
|        |          | AL - aluminum        | 3            | 4-11/16"    |
| 2"     | 260FXF   | OC - carbon steel    | 13           | 6-21/32"    |
|        |          | OS - stainless steel | 13           |             |
|        |          | AL - aluminum        | 7            | 6-7/32"     |
|        |          | BR - brass           | 14           |             |
|        |          | MI - ductile iron    | 13           |             |
| 3"     | 360FXF   | OC - carbon steel    | 23           | 8-9/64"     |
|        |          | OS - stainless steel | 23           |             |
|        |          | AL - aluminum        | 9            | 7-1/32"     |
|        |          | MI - ductile iron    | 19           |             |
| 4"     | 460FXF   | OC - carbon steel    | 61           | 12-3/8"     |
|        |          | AL - aluminum        | 13           | 9-1/8"      |

O-Ring Style 60 - 150# Flange x 150# Flange

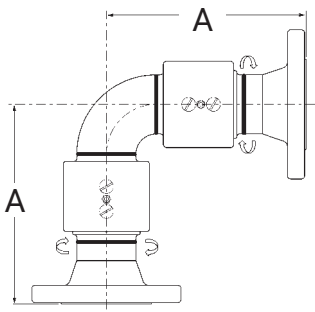

| Size   | Part #   | Material             | Weight (lbs) | Dimension A |
|--------|----------|----------------------|--------------|-------------|
| 1"     | 160FGXFG | OC - carbon steel    | 11           | 6-7/64"     |
|        |          | OS - stainless steel | 11           | 6-39/64"    |
| 1-1/2" | 1560FGFG | OC - carbon steel    | 13           | 7-7/8"      |
|        |          | OS - stainless steel | 13           |             |
|        |          | AL - aluminum        | 6            | 7-1/32"     |
| 2"     | 260FGXFG | OC - carbon steel    | 25           | 8-1/32"     |
|        |          | OS - stainless steel | 25           |             |
|        |          | AL - aluminum        | 11           | 8-5/8"      |
| 3"     | 360FGXFG | OC - carbon steel    | 35           | 9-7/8"      |
|        |          | OS - stainless steel | 35           |             |
|        |          | AL - aluminum        | 16           | 9-5/8"      |
| 4"     | 460FGXFG | OC - carbon steel    | 78           | 13"         |
|        |          | AL - aluminum        | 23           | 11-31/32"   |

**O-Ring Style 70 - FNPT x FNPT**

| Size              | Part #   | Material             | Weight (lbs) | Dimensions |          |
|-------------------|----------|----------------------|--------------|------------|----------|
|                   |          |                      |              | A          | B        |
| 1"                | 170FXF   | OC - carbon steel    | 8            | 4-59/64"   | 2-3/16"  |
|                   |          | OS - stainless steel | 8            | 5-59/64"   | 2-11/16" |
| 1-1/2"            | 15070FXF | OC - carbon steel    | 10           | 7-11/16"   | 3-15/32" |
|                   |          | OS - stainless steel | 10           |            |          |
|                   |          | AL - aluminum        | 3            | 6-1/8"     | 3"       |
| 2"                | 270FXF   | OC - carbon steel    | 15           | 7-17/32"   | 3-1/4"   |
|                   |          | OS - stainless steel | 15           |            |          |
|                   |          | AL - aluminum        | 8            | 6-11/16"   | 2-7/8"   |
|                   |          | BR - brass           | 16           |            |          |
| MI - ductile iron | 14       |                      |              |            |          |
| 3"                | 370FXF   | OC - carbon steel    | 25           | 10-1/8"    | 4-13/16" |
|                   |          | OS - stainless steel | 25           |            |          |
|                   |          | AL - aluminum        | 10           | 8-1/4"     | 3-7/8"   |
| 4"                | 470FXF   | OC - carbon steel    | 72           | 14"        | 6-3/8"   |
|                   |          | AL - aluminum        | 17           | 10-5/8"    | 4-3/4"   |

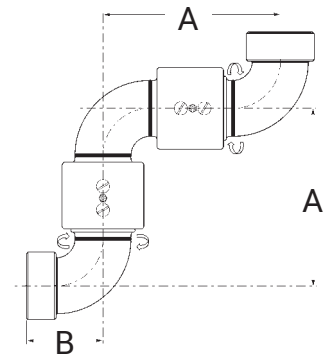

**O-Ring Style 70 - 150# Flange x 150# Flange**

| Size   | Part #   | Material             | Weight (lbs) | Dimensions |          |
|--------|----------|----------------------|--------------|------------|----------|
|        |          |                      |              | A          | B        |
| 1"     | 170FGXFG | OC - carbon steel    | 11           | 4-59/64"   | 3-3/16"  |
|        |          | OS - stainless steel | 11           | 5-59/64"   |          |
| 1-1/2" | 1570FGFG | OC - carbon steel    | 14           | 7-11/16"   | 4-11/16" |
|        |          | OS - stainless steel | 14           |            |          |
|        |          | AL - aluminum        | 6            | 6-1/8"     | 5-11/32" |
| 2"     | 270FGXFG | OC - carbon steel    | 23           | 7-17/32"   | 4-1/2"   |
|        |          | OS - stainless steel | 23           |            |          |
|        |          | AL - aluminum        | 12           | 6-11/16"   | 5-9/32"  |
| 3"     | 370FGXFG | OC - carbon steel    | 41           | 10-1/8"    | 5-3/4"   |
|        |          | OS - stainless steel | 41           |            |          |
|        |          | AL - aluminum        | 18           | 8-1/4"     | 6-15/32" |
| 4"     | 470FGXFG | OC - carbon steel    | 88           | 14"        | 7"       |
|        |          | AL - aluminum        | 27           | 15-5/16"   |          |

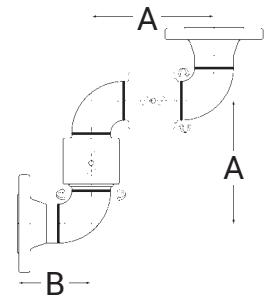

O-Ring Style 80 - FNPT x FNPT

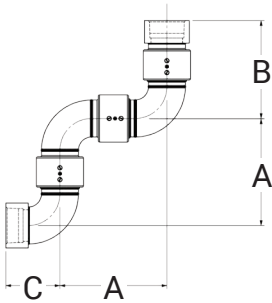

| Size   | Part #   | Material             | Weight (lbs) | Dimensions |         |          |
|--------|----------|----------------------|--------------|------------|---------|----------|
|        |          |                      |              | A          | B       | C        |
| 1"     | 180FXF   | OC - carbon steel    | 9            | 4-29/32"   | 5-3/32" | 2-3/16"  |
|        |          | OS - stainless steel | 9            |            |         |          |
| 1-1/2" | 15080FXF | OC - carbon steel    | 14           | 6-3/16"    | 6-1/4"  | 3-1/16"  |
|        |          | OS - stainless steel | 14           |            |         |          |
|        |          | AL - aluminum        | 6            |            |         |          |
| 2"     | 280FXF   | OC - carbon steel    | 19           | 7-17/32"   | 7-7/32" | 3-11/16" |
|        |          | OS - stainless steel | 19           |            |         |          |
|        |          | AL - aluminum        | 10           |            |         |          |
| 3"     | 380FXF   | OC - carbon steel    | 36           | 10-1/8"    | 9-1/4"  | 5-1/8"   |
|        |          | OS - stainless steel | 36           |            |         |          |
|        |          | AL - aluminum        | 17           |            |         |          |
| 4"     | 480FXF   | OC - carbon steel    | 88           | 14"        | 12-3/8" | 6-3/8"   |
|        |          | AL - aluminum        | 29           |            |         |          |

O-Ring Style 80 - 150# Flange x 150# Flange

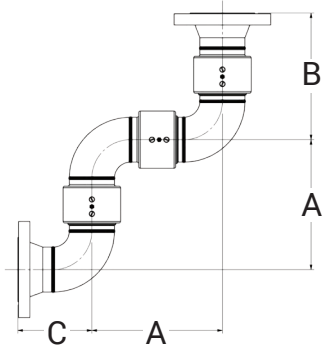

| Size   | Part #    | Material             | Weight (lbs) | Dimensions |        |          |
|--------|-----------|----------------------|--------------|------------|--------|----------|
|        |           |                      |              | A          | B      | C        |
| 1"     | 180FGXFG  | OC - carbon steel    | 12           | 5"         | 6"     | 3-13/64" |
|        |           | OS - stainless steel | 13           |            |        |          |
| 1-1/2" | 1580FGXFG | OC - carbon steel    | 19           | 6-13-64"   | 7-1/8" | 4"       |
|        |           | OS - stainless steel | 19           |            |        |          |
|        |           | AL - aluminum        | 7            |            |        |          |
| 2"     | 280FGXFG  | OC - carbon steel    | 28           | 7-1/2"     | 8"     | 4-1/2"   |
|        |           | OS - stainless steel | 28           |            |        |          |
|        |           | AL - aluminum        | 13           |            |        |          |
| 3"     | 380FGXFG  | OC - carbon steel    | 51           | 10-1/8"    | 9-7/8" | 5-3/4"   |
|        |           | OS - stainless steel | 51           |            |        |          |
|        |           | AL - aluminum        | 22           |            |        |          |
| 4"     | 480FGXFG  | OC - carbon steel    | 109          | 14"        | 13"    | 7"       |
|        |           | AL - aluminum        | 37           |            |        |          |



**O-Ring Style 10 - FNPT x FNPT**

| Size   | Part #   | Material             | Weight (lbs) | Dimensions |          |
|--------|----------|----------------------|--------------|------------|----------|
|        |          |                      |              | A          | B        |
| 1"     | 110FXF   | OC - carbon steel    | 9            | 5"         | 5"       |
|        |          | OS - stainless steel | 9            |            |          |
| 1-1/2" | 15010FXF | OC - carbon steel    | 13           | 6-13/64"   | 6-1/4"   |
|        |          | OS - stainless steel | 13           |            |          |
|        |          | AL - aluminum        | 5            |            |          |
| 2"     | 210FXF   | OC - carbon steel    | 18           | 7-1/2"     | 7-15/64" |
|        |          | OS - stainless steel | 19           |            |          |
|        |          | AL - aluminum        | 10           |            |          |
| 3"     | 310FXF   | OC - carbon steel    | 33           | 10-1/8"    | 9-1/4"   |
|        |          | OS - stainless steel | 33           |            |          |
|        |          | AL - aluminum        | 18           |            |          |
| 4"     | 410FXF   | OC - carbon steel    | 82           | 14"        | 12-3/8"  |
|        |          | OS - stainless steel | 82           |            |          |
|        |          | AL - aluminum        | 32           |            |          |

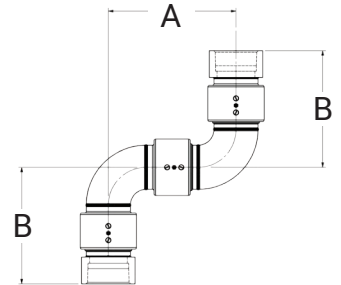

**O-Ring Style 10 - 150# Flange x 150# Flange**

| Size   | Part #   | Material             | Weight (lbs) | Dimensions |        |
|--------|----------|----------------------|--------------|------------|--------|
|        |          |                      |              | A          | B      |
| 1"     | 110FGXFG | OC - carbon steel    | 13           | 5"         | 6"     |
|        |          | OS - stainless steel | 13           |            |        |
| 1-1/2" | 1510FGFG | OC - carbon steel    | 18           | 6-13/64"   | 7-1/8" |
|        |          | OS - stainless steel | 18           |            |        |
|        |          | AL - aluminum        | 7            |            |        |
| 2"     | 210FGXFG | OC - carbon steel    | 27           | 7-1/2"     | 8"     |
|        |          | OS - stainless steel | 27           |            |        |
|        |          | AL - aluminum        | 11           |            |        |
| 3"     | 310FGXFG | OC - carbon steel    | 49           | 10-1/8"    | 9-7/8" |
|        |          | OS - stainless steel | 48           |            |        |
|        |          | AL - aluminum        | 17           |            |        |
| 4"     | 410FGXFG | OC - carbon steel    | 104          | 14"        | 13"    |
|        |          | AL - aluminum        | 29           |            |        |

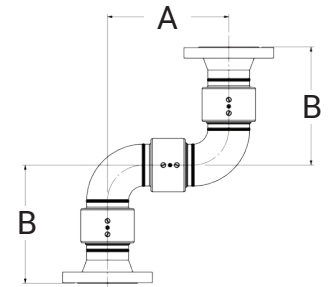

## Optional Seals for O-Ring Swivels

### O-Ring - Seal Materials

- Materials: Nitrile rubber, FKM, spring-loaded PTFE, food grade nitrile rubber, and EPDM seals

### Rebuild Kits for O-Ring Swivels

Each kit contains:

- 1 O-ring (pressure seal) in the material indicated
- 1 O-ring (dust seal) in the material indicated
- 2 ball retainer screws
- 1 grease plug
- 10 ball bearings

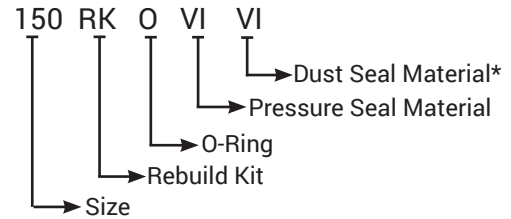

NOTE: All rebuild kits are per plane of rotation  
Different grade of ball bearing materials available upon request

| Size              | Nitrile rubber | FKM/Nitrile rubber | FKM/FKM    | PTFE/FKM    |
|-------------------|----------------|--------------------|------------|-------------|
| 1"                | 1RKOBUB        | 1RKOVIB            | 1RKOVIVB   | 1RKOTFVIB   |
| 1-1/4" and 1-1/2" | 150RKOBUB      | 150RKOVIB          | 150RKOVIVB | 150RKOTFVIB |
| 2"                | 2RKOBUB        | 2RKOVIB            | 2RKOVIVB   | 2RKOTFVIB   |
| 3"                | 3RKOBUB        | 3RKOVIB            | 3RKOVIVB   | 3RKOTFVIB   |
| 4"                | 4RKOBUB        | 4RKOVIB            | 4RKOVIVB   | ---         |

### Total Rebuild Kits for O-Ring Swivels

Each kit contains:

- 1 O-ring (pressure seal) in the material indicated
- 1 O-ring (dust seal) in the material indicated
- 2 ball retainer screws
- 1 grease plug
- Number of ball bearings varies depending on size

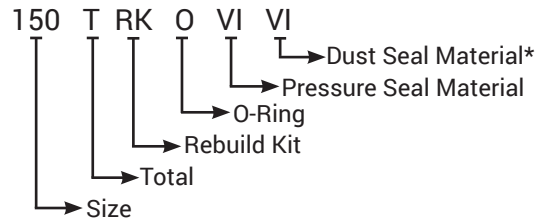

NOTE: All rebuild kits are per plane of rotation  
Different grade of ball bearing materials available upon request

| Size              | Nitrile rubber | FKM/Nitrile rubber | FKM/FKM     | PTFE/FKM     |
|-------------------|----------------|--------------------|-------------|--------------|
| 1"                | 1TRKOBUB       | 1TRKOVIB           | 1TRKOVIVB   | 1TRKOTFVIB   |
| 1-1/4" and 1-1/2" | 150TRKOBUB     | 150TRKOVIB         | 150TRKOVIVB | 150TRKOTFVIB |
| 2"                | 2TRKOBUB       | 2TRKOVIB           | 2TRKOVIVB   | 2TRKOTFVIB   |
| 3"                | 3TRKOBUB       | 3TRKOVIB           | 3TRKOVIVB   | 3TRKOTFVIB   |
| 4"                | 4TRKOBUB       | 4TRKOVIB           | 4TRKOVIVB   | ---          |

## Replacement Ball Bearings for O-Ring Swivels

| Size              | Quantity Per Plane of Rotation | Carbon Steel (standard) Part # | 440 Stainless Steel Part # | 316 Stainless Steel Part # |
|-------------------|--------------------------------|--------------------------------|----------------------------|----------------------------|
| 1"                | 40                             | 14CSBA                         | 14SSBA                     | 14SSBA-316                 |
| 1-1/4" and 1-1/2" | 56                             | 14CSBA                         | 14SSBA                     | 14SSBA-316                 |
| 2"                | 46                             | 38CSBA                         | 38SSBA                     | 38SSBA-316                 |
| 3"                | 62                             | 38CSBA                         | 38SSBA                     | 38SSBA-316                 |
| 4"                | 80                             | 38CSBA                         | 38SSBA                     | 38SSBA-316                 |

\*If the part number does not include characters for the dust seal, the kit will include a nitrile rubber dust seal.



## O-Ring Swivel Seal Replacement Procedure

NOTE: Instructions are not for assembly with spring-loaded PTFE pressure seal, consult Dixon®.

**1** Remove the ball retainer screws. Add a sufficient amount of solvent into each raceway to flush out the lubricant. Rotate the sleeve, catching the balls as they fall out. When all the balls have been removed, the body and sleeve can be separated. Discard old seals. Thoroughly clean the body and sleeve.



**4** Insert the sleeve into the body, slowly rotate the sleeve while inserting into the body.



**2** Install the new O-rings on the sleeve, dust seal to the rear, product (pressure) seal up front.

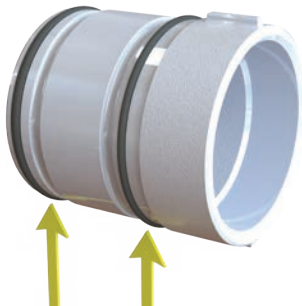

**5** When the sleeve is fully inserted, feed the ball bearings into the raceways while rotating the sleeve. To make space for all the balls, insert a screw driver into the raceway, while continuing to rotate the sleeve in one direction (be careful not to damage the threads). This will cause the balls to jam up, making room for the remaining balls. Now reverse rotation of sleeve and insert the remaining balls.



**3** Lubricate the body and the sleeve with grease.



**6** Reinstall ball retainer screws until tight. If this interferes with the smooth rotation of the ball bearings, then back off 1/8 - 1/4 turn. A thread locking sealant is recommended to prevent screws from backing off. After pressure testing, the unit is ready for installation.



 Body and sleeve are matched during manufacturing. Do not mix components with other units.

Visit Dixon's YouTube channel for more information [youtube.com/@DixonValve](https://www.youtube.com/@DixonValve)

## V-Ring Swivel Joints

### Applications

- Commonly used in the steel industry, marine bulk transfer, waste water treatment plants, and petrochemical industry.

### Sizes

- 2" - 14"

### Features

- V-ring, also known as chevron packing, is a multiple lip seal known for its reliability and long life.
- The three V-ring seals are designed to seal even under misalignment caused by race wear from years of service. This design results in longer time between service periods, increased up-time efficiencies, and lower maintenance costs.
- Spring-loaded triple V-ring sealing system ensures a leak-proof seal at high or low pressure and extends seal life
- Swivels are shipped standard with the following:
  - Nitrile rubber pressure seals and dust seals
  - Carbon steel ball bearings
  - PTFE retainers
- Available working pressure ratings up to **1,000 PSI**
- End connections and materials offered may vary based on size, contact Dixon® for details

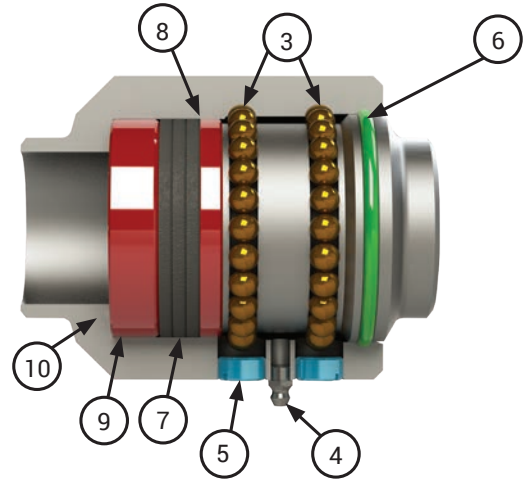

### Materials

- Available materials include carbon steel, 316L stainless steel, and aluminum

### Bill of Materials

1. Body
2. Sleeve
3. Ball bearings
4. Grease fitting
5. Ball retainer screws
6. O-ring (dust seal)
7. V-ring (pressure seal)
8. Seal retainer
9. Spring retainer
10. Springs

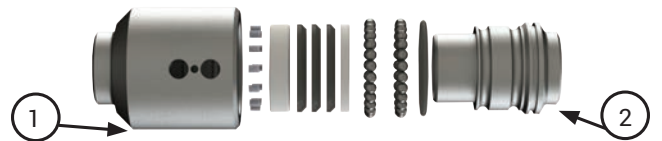

### V-Ring Swivel Joint Numbering System

| 2            | 20    | F              | x | F              | CS                               | 0                      | 0                      | 2                  | 0                       | 0                   |
|--------------|-------|----------------|---|----------------|----------------------------------|------------------------|------------------------|--------------------|-------------------------|---------------------|
| Sizes Inches | Style | End Connection | x | End Connection | Material                         | Pressure Seal          | Dust Seal              | Retainers          | Ball Bearings           | Grease              |
| 2 = 2"       | 20    | F (FNPT)       | x | F (FNPT)       | AL = Aluminum                    | 0 = nitrile rubber     | 0 = nitrile rubber     | 2 = PTFE retainers | 0 = CS carbon steel     | 0 = lithium         |
| 3 = 3"       | 30    | W (weld)       | x | W (weld)       | CS = V-ring carbon steel         | 1 = FKM                | 1 = FKM                |                    | 1 = 440 stainless steel | 1 = food grade      |
| 4 = 4"       | 40    | FG (150#)      | x | FG (150#)      | SS = V-ring 316L stainless steel | 2 = PTFE               |                        |                    | 2 = 316 stainless steel | 2 = silicone        |
| 6 = 6"       | 50    | PF (300#)      | x | PF (300#)      |                                  | 3 = EPDM               | 3 = EPDM               |                    |                         | 3 = Tribolube       |
| 8 = 8"       | 60    | TF (TTMA)      | x | TF (TTMA)      |                                  | 4 = FDA nitrile rubber | 4 = FDA nitrile rubber |                    |                         | 4 = low temperature |
| 10 = 10"     | 70    | BP (BSPP)      | x | BP (BSPP)      |                                  | 5 = No seal            | 5 = No seal            |                    |                         | 5 = no grease       |
| 12 = 12"     | 80    | BT (BSPT)      | x | BT (BSPT)      |                                  |                        |                        |                    |                         |                     |
| 14 = 14"     | 10    | G (groove)     | x | G (groove)     |                                  |                        |                        |                    |                         |                     |
|              |       | M (MNPT)       | x | M (MNPT)       |                                  |                        |                        |                    |                         |                     |

NOTE: Other end connections or seals are available upon request.

- Standard grease fitting without ball check. Ask for ball check if required.
- Aluminum V-ring version only available in 6" and 8"

**V-Ring Style 20 - Weld x Weld**

| Size | Part #  | Material             | Weight (lbs) | Dimension A |
|------|---------|----------------------|--------------|-------------|
| 2"   | 220WXW  | CS - carbon steel    | 9            | 5-5/16"     |
|      |         | SS - stainless steel | 9            |             |
| 3"   | 320WXW  | CS - carbon steel    | 13           | 5-3/4"      |
|      |         | SS - stainless steel | 13           |             |
| 4"   | 420WXW  | CS - carbon steel    | 24           | 7"          |
|      |         | SS - stainless steel | 25           |             |
| 6"   | 620WXW  | CS - carbon steel    | 55           | 8-3/8"      |
|      |         | SS - stainless steel | 57           |             |
|      |         | AL - aluminum        | 22           |             |
| 8"   | 820WXW  | CS - carbon steel    | 78           | 8-5/8"      |
|      |         | SS - stainless steel | 92           |             |
|      |         | AL - aluminum        | 35           |             |
| 10"  | 1020WXW | CS - carbon steel    | 190          | 11-5/8"     |
|      |         | SS - stainless steel | 193          |             |
| 12"  | 1220WXW | CS - carbon steel    | 208          | 11-11/32"   |
|      |         | SS - stainless steel | 211          |             |
| 14"  | 1420WXW | CS - carbon steel    | 246          | 11-3/4"     |

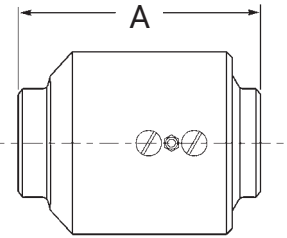

**V-Ring Style 20 - FNPT x FNPT**

| Size | Part # | Material             | Weight (lbs) | Dimension A |
|------|--------|----------------------|--------------|-------------|
| 2"   | 220FXF | CS - carbon steel    | 13           | 8-11/16"    |
|      |        | SS - stainless steel | 12           |             |
| 3"   | 320FXF | CS - carbon steel    | 17           | 10"         |
|      |        | SS - stainless steel | 18           |             |
| 4"   | 420FXF | CS - carbon steel    | 37           | 11-3/4"     |
|      |        | SS - stainless steel | 38           |             |
| 6"   | 620FXF | CS - carbon steel    | 68           | 12-1/8"     |
|      |        | SS - stainless steel | 70           |             |
|      |        | AL - aluminum        | 26           |             |

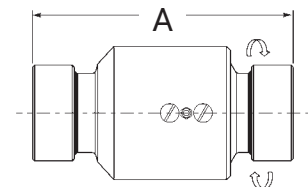
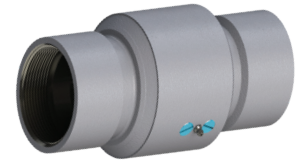

**V-Ring Style 20 - 150# Flange x 150# Flange**

| Size | Part #   | Material             | Weight (lbs)                               | Dimension A |
|------|----------|----------------------|--|-------------|
| 2"   | 220FGXFG | CS - carbon steel    | 22   | 10-5/16"    |
|      |          | SS - stainless steel | 21   |             |
| 3"   | 320FGXFG | CS - carbon steel    | 36   | 11-1/4"     |
|      |          | SS - stainless steel | 35   |             |
| 4"   | 420FGXFG | CS - carbon steel    | 57   | 13"         |
|      |          | SS - stainless steel | 58   |             |
| 6"   | 620FGXFG | CS - carbon steel    | 104  | 15-3/8"     |
|      |          | SS - stainless steel | 106  |             |
|      |          | AL - aluminum        | 39   |             |
| 8"   | 820FGXFG | CS - carbon steel    | 162  | 16-5/8"     |
|      |          | SS - stainless steel | 170  |             |
|      |          | AL - aluminum        | 61   |             |
| 10"  | 1020FGFG | CS - carbon steel    | 296  | 19-5/8"     |
|      |          | SS - stainless steel | 300  |             |
| 12"  | 1220FGFG | CS - carbon steel    | 369  | 20-11/32"   |
|      |          | SS - stainless steel | 374  |             |
| 14"  | 1420FGFG | CS - carbon steel    | Contact factory for weights and dimensions |             |

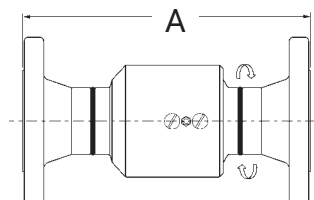
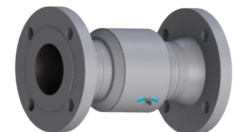



V-Ring Style 30 - FNPT x FNPT



| Size | Part # | Material             | Weight (lbs) | Dimensions |          |
|------|--------|----------------------|--------------|------------|----------|
|      |        |                      |              | A          | B        |
| 2"   | 230FXF | CS - carbon steel    | 12           | 9"         | 3-11/16" |
|      |        | SS - stainless steel | 12           |            |          |
| 3"   | 330FXF | CS - carbon steel    | 21           | 10-7/8"    | 5-1/8"   |
|      |        | SS - stainless steel | 21           |            |          |
| 4"   | 430FXF | CS - carbon steel    | 42           | 13-3/8"    | 6-3/8"   |
|      |        | SS - stainless steel | 44           |            |          |
| 6"   | 630FXF | CS - carbon steel    | 84           | 16-1/4"    | 7-7/8"   |
|      |        | SS - stainless steel | 84           |            |          |
|      |        | AL - aluminum        | 32           |            |          |

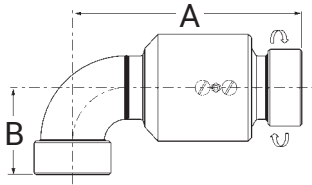

V-Ring Style 30 - 150# Flange x 150# Flange



| Size | Part #   | Material             | Weight (lbs)                               | Dimensions |         |
|------|----------|----------------------|--|------------|---------|
|      |          |                      |  | A          | B       |
| 2"   | 230FGXFG | CS - carbon steel    | 23   | 9-13/16"   | 4-1/2"  |
|      |          | SS - stainless steel | 22   |            |         |
| 3"   | 330FGXFG | CS - carbon steel    | 39   | 11-1/2"    | 5-3/4"  |
|      |          | SS - stainless steel | 38   |            |         |
| 4"   | 430FGXFG | CS - carbon steel    | 64   | 14"        | 7"      |
|      |          | SS - stainless steel | 65   |            |         |
| 6"   | 630FGXFG | CS - carbon steel    | 121  | 17-7/8"    | 9-1/2"  |
|      |          | SS - stainless steel | 121  |            |         |
|      |          | AL - aluminum        | 45   |            |         |
| 8"   | 830FGXFG | CS - carbon steel    | 196  | 20-5/8"    | 12"     |
|      |          | SS - stainless steel | 208  |            |         |
|      |          | AL - aluminum        | 77   |            |         |
| 10"  | 1030FGFG | CS - carbon steel    | 343  | 25-27/32"  | 14"     |
|      |          | SS - stainless steel | 347  |            |         |
| 12"  | 1230FGFG | CS - carbon steel    | 451  | 27-27/32"  | 16-1/2" |
|      |          | SS - stainless steel | 457  |            |         |
| 14"  | 1430FGFG | CS - carbon steel    | Contact factory for weights and dimensions |            |         |

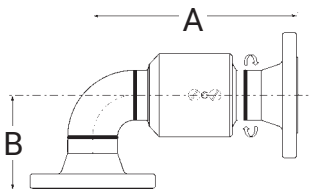

**V-Ring Style 40 - FNPT x FNPT**

| Size | Part # | Material             | Weight (lbs) | Dimensions |          |         |
|------|--------|----------------------|--------------|------------|----------|---------|
|      |        |                      |              | A          | B        | C       |
| 2"   | 240FXF | CS - carbon steel    | 13           | 9-5/16"    | 3-11/16" | 7-3/8"  |
|      |        | SS - stainless steel | 13           |            |          |         |
| 3"   | 340FXF | CS - carbon steel    | 24           | 11-3/4"    | 5-1/8"   | 10-1/4" |
|      |        | SS - stainless steel | 24           |            |          |         |
| 4"   | 440FXF | CS - carbon steel    | 47           | 15"        | 6-3/8"   | 12-3/4" |
|      |        | SS - stainless steel | 51           |            |          |         |
| 6"   | 640FXF | CS - carbon steel    | 101          | 20-3/8"    | 7-7/8"   | 15-3/4" |
|      |        | SS - stainless steel | 99           |            |          |         |
|      |        | AL - aluminum        | 39           |            |          |         |

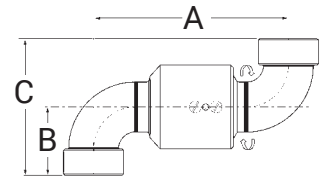

**V-Ring Style 40 - 150# Flange x 150# Flange**

| Size | Part #   | Material             | Weight (lbs)                               | Dimensions |         |         |
|------|----------|----------------------|--|------------|---------|---------|
|      |          |                      |  | A          | B       | C       |
| 2"   | 240FGXFG | CS - carbon steel    | 24   | 9-5/16"    | 4-1/2"  | 9"      |
|      |          | SS - stainless steel | 23   |            |         |         |
| 3"   | 340FGXFG | CS - carbon steel    | 49   | 11-3/4"    | 5-3/4"  | 11-1/2" |
|      |          | SS - stainless steel | 41   |            |         |         |
| 4"   | 440FGXFG | CS - carbon steel    | 70   | 15"        | 7"      | 14"     |
|      |          | SS - stainless steel | 72   |            |         |         |
| 6"   | 640FGXFG | CS - carbon steel    | 138  | 20-3/8"    | 9-1/2"  | 19"     |
|      |          | SS - stainless steel | 136  |            |         |         |
|      |          | AL - aluminum        | 52   |            |         |         |
| 8"   | 840FGXFG | CS - carbon steel    | 230  | 24-5/8"    | 12"     | 24"     |
|      |          | SS - stainless steel | 246  |            |         |         |
|      |          | AL - aluminum        | 92   |            |         |         |
| 10"  | 1040FGFG | CS - carbon steel    | 395  | 31-1/16"   | 14"     | 28"     |
|      |          | SS - stainless steel | 400  |            |         |         |
| 12"  | 1240FGFG | CS - carbon steel    | 533  | 35-11/32"  | 16-1/2" | 33"     |
|      |          | SS - stainless steel | 540  |            |         |         |
| 14"  | 1440FGFG | CS - carbon steel    | Contact factory for weights and dimensions |            |         |         |

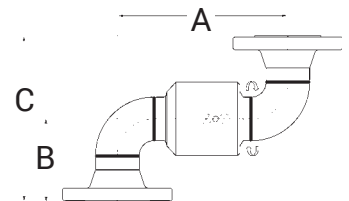

V-Ring Style 50 - FNPT x FNPT

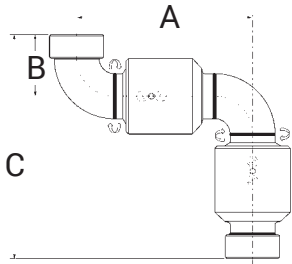

| Size | Part # | Material             | Weight (lbs) | Dimensions |          |           |
|------|--------|----------------------|--------------|------------|----------|-----------|
|      |        |                      |              | A          | B        | C         |
| 2"   | 250FXF | CS - carbon steel    | 23           | 9-5/16"    | 3-11/16" | 12-11/16" |
|      |        | SS - stainless steel | 23           |            |          |           |
| 3"   | 350FXF | CS - carbon steel    | 37           | 11-3/4"    | 5-1/8"   | 16"       |
|      |        | SS - stainless steel | 37           |            |          |           |
| 4"   | 450FXF | CS - carbon steel    | 73           | 15"        | 6-3/8"   | 19-3/4"   |
|      |        | SS - stainless steel | 76           |            |          |           |
| 6"   | 650FXF | CS - carbon steel    | 156          | 20-3/8"    | 7-7/8"   | 24-1/8"   |
|      |        | SS - stainless steel | 155          |            |          |           |
|      |        | AL - aluminum        | 61           |            |          |           |

V-Ring Style 50 - 150# Flange x 150# Flange

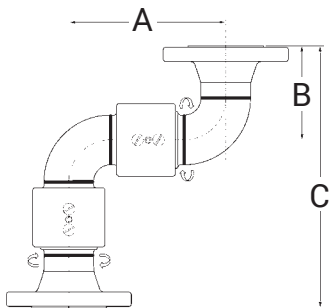

| Size | Part #   | Material             | Weight (lbs)                               | Dimensions |         |           |
|------|----------|----------------------|--|------------|---------|-----------|
|      |          |                      |  | A          | B       | C         |
| 2"   | 250FGXFG | CS - carbon steel    | 33   | 9-5/16"    | 4-1/2"  | 14-5/16"  |
|      |          | SS - stainless steel | 32   |            |         |           |
| 3"   | 350FGXFG | CS - carbon steel    | 56   | 11-3/4"    | 5-3/4"  | 17-1/4"   |
|      |          | SS - stainless steel | 54   |            |         |           |
| 4"   | 450FGXFG | CS - carbon steel    | 94   | 15"        | 7"      | 21"       |
|      |          | SS - stainless steel | 97   |            |         |           |
| 6"   | 650FGXFG | CS - carbon steel    | 192  | 20-3/8"    | 9-1/2"  | 27-3/8"   |
|      |          | SS - stainless steel | 192  |            |         |           |
|      |          | AL - aluminum        | 74   |            |         |           |
| 8"   | 850FGXFG | CS - carbon steel    | 309  | 24-5/8"    | 12"     | 32-5/8"   |
|      |          | SS - stainless steel | 338  |            |         |           |
|      |          | AL - aluminum        | 128  |            |         |           |
| 10"  | 1050FGFG | CS - carbon steel    | 585  | 31-27/32"  | 14"     | 39-5/8"   |
|      |          | SS - stainless steel | 592  |            |         |           |
| 12"  | 1250FGFG | CS - carbon steel    | 741  | 35-11/32"  | 16-1/2" | 44-11/32" |
|      |          | SS - stainless steel | 751  |            |         |           |
| 14"  | 1450FGFG | CS - carbon steel    | Contact factory for weights and dimensions |            |         |           |

**V-Ring Style 60 - FNPT x FNPT**

| Size | Part # | Material             | Weight (lbs) | Dimension A |
|------|--------|----------------------|--------------|-------------|
| 2"   | 260FXF | CS - carbon steel    | 22           | 9"          |
|      |        | SS - stainless steel | 22           |             |
| 3"   | 360FXF | CS - carbon steel    | 34           | 10-7/8"     |
|      |        | SS - stainless steel | 34           |             |
| 4"   | 460FXF | CS - carbon steel    | 72           | 13-3/8"     |
|      |        | SS - stainless steel | 72           |             |
| 6"   | 660FXF | CS - carbon steel    | 118          | 16-1/4"     |
|      |        | SS - stainless steel | 140          |             |
|      |        | AL - aluminum        | 56           |             |

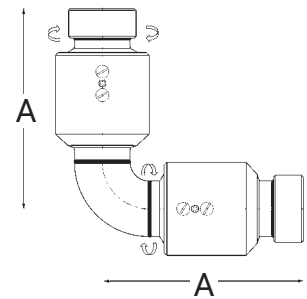

**V-Ring Style 60 - 150# Flange x 150# Flange**

| Size | Part #   | Material             | Weight (lbs)                               | Dimension A |
|------|----------|----------------------|--|-------------|
| 2"   | 260FGXFG | CS - carbon steel    | 42   | 9-13/16"    |
|      |          | SS - stainless steel | 42   |             |
| 3"   | 360FGXFG | CS - carbon steel    | 83   | 11-1/2"     |
|      |          | SS - stainless steel | 83   |             |
| 4"   | 460FGXFG | CS - carbon steel    | 106  | 14"         |
|      |          | SS - stainless steel | 106  |             |
| 6"   | 660FGXFG | CS - carbon steel    | 172  | 17-7/8"     |
|      |          | SS - stainless steel | 172  |             |
|      |          | AL - aluminum        | 69   |             |
| 8"   | 860FGXFG | CS - carbon steel    | 312  | 20-5/8"     |
|      |          | SS - stainless steel | 312  |             |
|      |          | AL - aluminum        | 117  |             |
| 10"  | 1060FGFG | CS - carbon steel    | 535  | 25-27/32"   |
|      |          | SS - stainless steel | 542  |             |
| 12"  | 1260FGFG | CS - carbon steel    | 660  | 27-27/32"   |
|      |          | SS - stainless steel | 668  |             |
| 14"  | 1460FGFG | CS - carbon steel    | Contact factory for weights and dimensions |             |

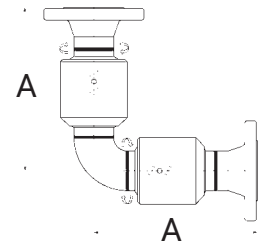

**V-Ring Style 70 - FNPT x FNPT**

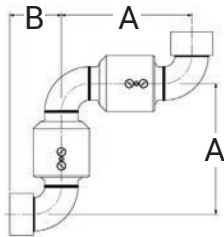

| Size | Part # | Material             | Weight (lbs) | Dimensions |          |
|------|--------|----------------------|--------------|------------|----------|
|      |        |                      |              | A          | B        |
| 2"   | 270FXF | CS - carbon steel    | 24           | 9-5/16"    | 3-11/16" |
|      |        | SS - stainless steel | 24           |            |          |
| 3"   | 370FXF | CS - carbon steel    | 42           | 11-3/4"    | 5-1/8"   |
|      |        | SS - stainless steel | 42           |            |          |
| 4"   | 470FXF | CS - carbon steel    | 79           | 15"        | 6-3/8"   |
|      |        | SS - stainless steel | 79           |            |          |
| 6"   | 670FXF | CS - carbon steel    | 168          | 20-3/8"    | 7-7/8"   |
|      |        | SS - stainless steel | 168          |            |          |
|      |        | AL - aluminum        | 64           |            |          |

**V-Ring Style 70 - 150# Flange x 150# Flange**

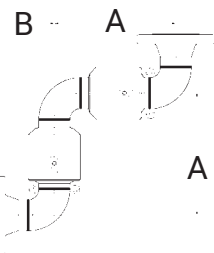

| Size | Part #   | Material             | Weight (lbs)                               | Dimensions |         |
|------|----------|----------------------|--|------------|---------|
|      |          |                      |  | A          | B       |
| 2"   | 270FGXFG | CS - carbon steel    | 34   | 9-5/16"    | 4-1/2"  |
|      |          | SS - stainless steel | 33   |            |         |
| 3"   | 370FGXFG | CS - carbon steel    | 59   | 11-3/4"    | 5-3/4"  |
|      |          | SS - stainless steel | 57   |            |         |
| 4"   | 470FGXFG | CS - carbon steel    | 100  | 15"        | 7"      |
|      |          | SS - stainless steel | 103  |            |         |
| 6"   | 670FGXFG | CS - carbon steel    | 209  | 20-3/8"    | 9-1/2"  |
|      |          | SS - stainless steel | 207  |            |         |
|      |          | AL - aluminum        | 82   |            |         |
| 8"   | 870FGXFG | CS - carbon steel    | 343  | 24-5/8"    | 12"     |
|      |          | SS - stainless steel | 376  |            |         |
|      |          | AL - aluminum        | 143  |            |         |
| 10"  | 1070FGFG | CS - carbon steel    | 637  | 31-27/32"  | 14"     |
|      |          | SS - stainless steel | 645  |            |         |
| 12"  | 1270FGFG | CS - carbon steel    | 823  | 35-11/32"  | 16-1/2" |
|      |          | SS - stainless steel | 834  |            |         |
| 14"  | 1470FGFG | CS - carbon steel    | Contact factory for weights and dimensions |            |         |



**V-Ring Style 80 - FNPT x FNPT**

| Size | Part # | Material             | Weight (lbs) | Dimensions |         |          |
|------|--------|----------------------|--------------|------------|---------|----------|
|      |        |                      |              | A          | B       | C        |
| 2"   | 280FXF | CS - carbon steel    | 33           | 9-5/16"    | 9-9/16" | 3-11/16" |
|      |        | SS - stainless steel | 34           |            |         |          |
| 3"   | 380FXF | CS - carbon steel    | 53           | 11-3/4"    | 10-7/8" | 5-1/8"   |
|      |        | SS - stainless steel | 53           |            |         |          |
| 4"   | 480FXF | CS - carbon steel    | 104          | 15"        | 13-3/8" | 6-3/8"   |
|      |        | SS - stainless steel | 108          |            |         |          |
| 6"   | 680FXF | CS - carbon steel    | 227          | 20-3/8"    | 16-1/4" | 7-7/8"   |
|      |        | SS - stainless steel | 227          |            |         |          |
|      |        | AL - aluminum        | 89           |            |         |          |

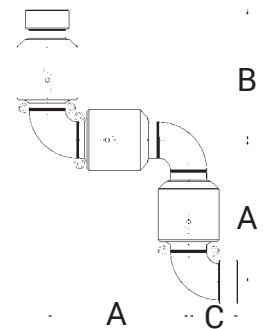

**V-Ring Style 80 - 150# Flange x 150# Flange**

| Size | Part #   | Material             | Weight (lbs)                               | Dimensions |           |         |
|------|----------|----------------------|--|------------|-----------|---------|
|      |          |                      |  | A          | B         | C       |
| 2"   | 280FGXFG | CS - carbon steel    | 43   | 9-5/16"    | 9-13/16"  | 4-1/2"  |
|      |          | SS - stainless steel | 42   |            |           |         |
| 3"   | 380FGXFG | CS - carbon steel    | 72   | 11-3/4"    | 11-1/2"   | 5-3/4"  |
|      |          | SS - stainless steel | 70   |            |           |         |
| 4"   | 480FGXFG | CS - carbon steel    | 125  | 15"        | 14"       | 7"      |
|      |          | SS - stainless steel | 128  |            |           |         |
| 6"   | 680FGXFG | CS - carbon steel    | 264  | 20-3/8"    | 17-7/8"   | 9-1/2"  |
|      |          | SS - stainless steel | 263  |            |           |         |
|      |          | AL - aluminum        | 102  |            |           |         |
| 8"   | 880FGXFG | CS - carbon steel    | 421  | 24-5/8"    | 20-5/8"   | 12"     |
|      |          | SS - stainless steel | 468  |            |           |         |
|      |          | AL - aluminum        | 178  |            |           |         |
| 10"  | 1080FGFG | CS - carbon steel    | 827  | 31-19/32"  | 25-19/32" | 14"     |
|      |          | SS - stainless steel | 838  |            |           |         |
| 12"  | 1280FGFG | CS - carbon steel    | 1032                                       | 35-11/32"  | 27-27/32" | 16-1/2" |
|      |          | SS - stainless steel | 1045                                       |            |           |         |
| 14"  | 1480FGFG | CS - carbon steel    | Contact factory for weights and dimensions |            |           |         |

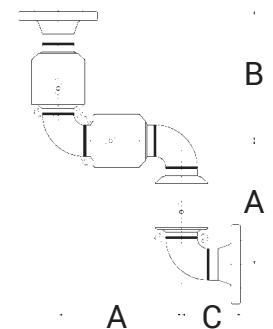

V-Ring Style 10 - FNPT x FNPT

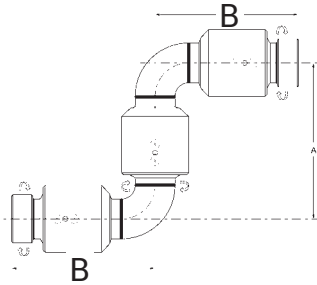

| Size | Part # | Material             | Weight (lbs) | Dimensions |         |
|------|--------|----------------------|--------------|------------|---------|
|      |        |                      |              | A          | B       |
| 2"   | 210FXF | CS - carbon steel    | 32           | 9-5/16"    | 9"      |
|      |        | SS - stainless steel | 33           |            |         |
| 3"   | 310FXF | CS - carbon steel    | 50           | 11-3/4"    | 10-7/8" |
|      |        | SS - stainless steel | 50           |            |         |
| 4"   | 410FXF | CS - carbon steel    | 97           | 15"        | 13-3/8" |
|      |        | SS - stainless steel | 101          |            |         |
| 6"   | 610FXF | CS - carbon steel    | 210          | 20-3/8"    | 16-1/4" |
|      |        | SS - stainless steel | 200          |            |         |
|      |        | AL - aluminum        | 69           |            |         |

V-Ring Style 10 - 150# Flange x 150# Flange

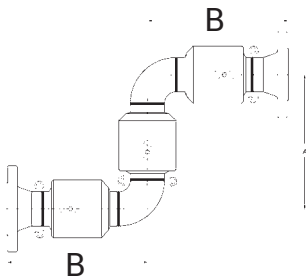

| Size | Part #   | Material             | Weight (lbs)                               | Dimensions |           |
|------|----------|----------------------|--|------------|-----------|
|      |          |                      |  | A          | B         |
| 2"   | 210FGXFG | CS - carbon steel    | 42   | 9-5/16"    | 9-13/16"  |
|      |          | SS - stainless steel | 41   |            |           |
| 3"   | 310FGXFG | CS - carbon steel    | 69   | 11-3/4"    | 11-1/2"   |
|      |          | SS - stainless steel | 67   |            |           |
| 4"   | 410FGXFG | CS - carbon steel    | 119  | 15"        | 14"       |
|      |          | SS - stainless steel | 122  |            |           |
| 6"   | 610FGXFG | CS - carbon steel    | 222  | 20-3/8"    | 17-7/8"   |
|      |          | SS - stainless steel | 234  |            |           |
|      |          | AL - aluminum        | 97   |            |           |
| 8"   | 810FGXFG | CS - carbon steel    | 387  | 24-5/8"    | 20-5/8"   |
|      |          | SS - stainless steel | 430  |            |           |
|      |          | AL - aluminum        | 163  |            |           |
| 10"  | 1010FGFG | CS - carbon steel    | 775  | 31-1/16"   | 25-27/32" |
|      |          | SS - stainless steel | 785  |            |           |
| 12"  | 1210FGFG | CS - carbon steel    | 950  | 35-11/32"  | 27-27/32" |
|      |          | SS - stainless steel | 962  |            |           |
| 14"  | 1410FGFG | CS - carbon steel    | Contact factory for weights and dimensions |            |           |

## Repair Parts For V-Ring Swivels

### V-Ring - Seal Material

- Materials: Nitrile rubber, FKM, PTFE, food grade nitrile rubber, and EPDM seals

### Rebuild Kits for V-Ring Swivels

Each kit contains:

- 3 V-ring (pressure seal) in the material indicated
- 1 dust seal in the material indicated
- 2 ball retainer screws
- 1 grease plug
- 10 ball bearings

NOTE: All rebuild kits are per plane of rotation  
Different grade of ball bearing materials available upon request

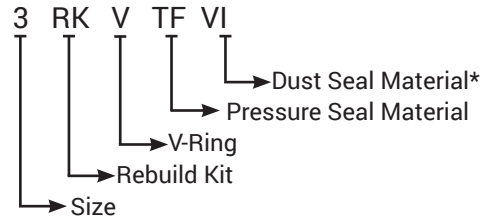

| Size | Nitrile rubber | FKM/Nitrile rubber | FKM/FKM   | PTFE/FKM  |
|------|----------------|--------------------|-----------|-----------|
| 2"   | 2RKVBV         | 2RKVVV             | 2RKVVVVI  | 2RKVTFVI  |
| 3"   | 3RKVBV         | 3RKVVV             | 3RKVVVVI  | 3RKVTFVI  |
| 4"   | 4RKVBV         | 4RKVVV             | 4RKVVVVI  | 4RKVTFVI  |
| 6"   | 6RKVBV         | 6RKVVV             | 6RKVVVVI  | 6RKVTFVI  |
| 8"   | 8RKVBV         | 8RKVVV             | 8RKVVVVI  | 8RKVTFVI  |
| 10"  | 10RKVBV        | 10RKVVV            | 10RKVVVVI | 10RKVTFVI |
| 12"  | 12RKVBV        | 12RKVVV            | 12RKVVVVI | 12RKVTFVI |

### Total Rebuild Kits for V-Ring Swivels

Each kit contains:

- 3 V-ring (pressure seal) in the material indicated
- 1 dust seal in the material indicated
- 2 ball retainer screws
- Number of grease plugs varies depending on size
- 2 PTFE retainers
- Number of ball bearings varies depending on size

NOTE: All rebuild kits are per plane of rotation  
Different grade of ball bearing materials available upon request

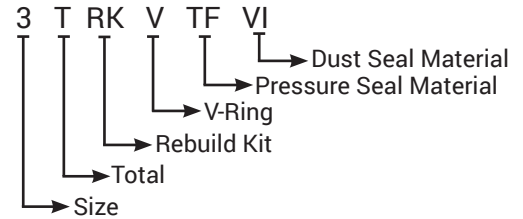

| Size | Nitrile rubber | FKM/Nitrile rubber | FKM/FKM  | PTFE/FKM  |
|------|----------------|--------------------|----------|-----------|
| 2"   | 2TRKBU         | 2TRKVI             | 2TRKVIVI | 2TRKTFVI  |
| 3"   | 3TRKBU         | 3TRKVI             | 3TRKVIVI | 3TRKTFVI  |
| 4"   | 4TRKBU         | 4TRKVI             | 4TRKVIVI | 4TRKTFVI  |
| 6"   | 6TRKBU         | 6TRKVI             | 6TRKVIVI | 6TRKTFVI  |
| 8"   | 8TRKBU         | 8TRKVI             | 8TRKVIVI | 8TRKVTFVI |

## Replacement Ball Bearings for V-Ring Swivels

- Materials: carbon steel, 440 stainless steel or 316 stainless steel

| Size | Quantity Per Plane of Rotation | Carbon Steel (standard) Part # | 440 Stainless Steel Part # | 316 Stainless Steel Part # |
|------|--------------------------------|--------------------------------|----------------------------|----------------------------|
| 2"   | 48                             | 38CSBA                         | 38SSBA                     | 38SSBA-316                 |
| 3"   | 66                             | 38CSBA                         | 38SSBA                     | 38SSBA-316                 |
| 4"   | 86                             | 38CSBA                         | 38SSBA                     | 38SSBA-316                 |
| 6"   | 98                             | 12CSBA                         | 12SSBA                     | 12SSBA-316                 |
| 8"   | 80                             | 34CSBA                         | 34SSBA                     | 34SSBA-316                 |
| 10"  | 82                             | 1CSBA                          | 1SSBA                      | 1SSBA-316                  |
| 12"  | 86                             | 1CSBA                          | 1SSBA                      | 1SSBA-316                  |
| 14"  | 96                             | 1CSBA                          | 1SSBA                      | 1SSBA-316                  |

\*If the part number does not include characters for the dust seal, the kit will include a nitrile rubber dust seal.



## V-Ring Swivel Seal Replacement Procedure

**1** Remove the ball retainer screws. Add a sufficient amount of solvent into each raceway to flush out the lubricant. Rotate the sleeve, catching the balls as they fall out. When all the balls have been removed, the body and sleeve can be separated. Discard old seals. Thoroughly clean the body, sleeve retainer, spring retainer, and springs.



**2** Lubricate the body unit with a Moly lubricant or equivalent.



**3** Place the assembled spring retainer unit (spring end first) into the body\*. Place the set of V-rings onto the spring retainer. Be sure V-rings are installed with the sealing lips facing toward the retainer. Lubricate the body and seals with a moly lubricant or equivalent.



**4** Set the dust seal into O-ring groove on the sleeve. Place the seal retainer on the sleeve with the grooved end facing the V-rings. Lubricate the sleeve with grease.



**5** Insert sleeve into body, compressing swivel joint together until ball races or body and sleeve are in alignment (do not rotate either unit while compressing). Care should be taken to avoid pinching or scoring of V-rings. Drop balls into raceway holes, rotating the sleeve slowly as you load. To make space for all the balls, insert a screw driver into the raceway while continuing to rotate the sleeve in one direction (be careful not to damage the threads). This will cause the balls to jam up, making room for the remaining balls. Now reverse the rotation of the sleeve and insert the remaining balls.



**6** Reinstall ball retainer screws until tight. If this interferes with the smooth rotation of the ball bearings, then back off 1/8 - 1/4 turn. A thread locking sealant is recommended to prevent screws from backing off. After pressure testing, the unit is ready for installation.



\* The last coil of the springs has been upset (O.D. slightly larger). When upset end is inserted into the holes provided in the spring retainer, the springs remain secure.



Body and sleeve are matched during manufacturing. Do not mix components with other units.

Visit Dixon's YouTube channel for more information [youtube.com/@DixonValve](https://youtube.com/@DixonValve)

## Cap Seal Swivel Joints

### Applications

- Liquid media transfer lines in steel-making plants, floating roof drains, and floating suction systems



### Sizes

- 14" – 24"

### Features

- Pressure seal consists of a nitrile or FKM energizer with glass Moly filled PTFE outer cap seal allowing for a lower torque requirement to rotate
- Nitrile or FKM X-ring dust seal for additional reduction in required torque to rotate
- Triple ball-race design for 18" and larger
- Hardened ball races for increased load capacities of carbon steel swivels
- Available end connections include 150# and 300# flanges and weld ends. Contact Dixon® for more details

### Materials

- Carbon steel and 316L stainless steel

### Bill of Materials

1. Body
2. Sleeve
3. Ball bearings (14" - 16" = 2 ball races, 18" - 24" = 3 ball races)
4. Grease fitting
5. Ball retainer screws
6. Dust seal (X-ring)
7. Pressure seal (cap seal)

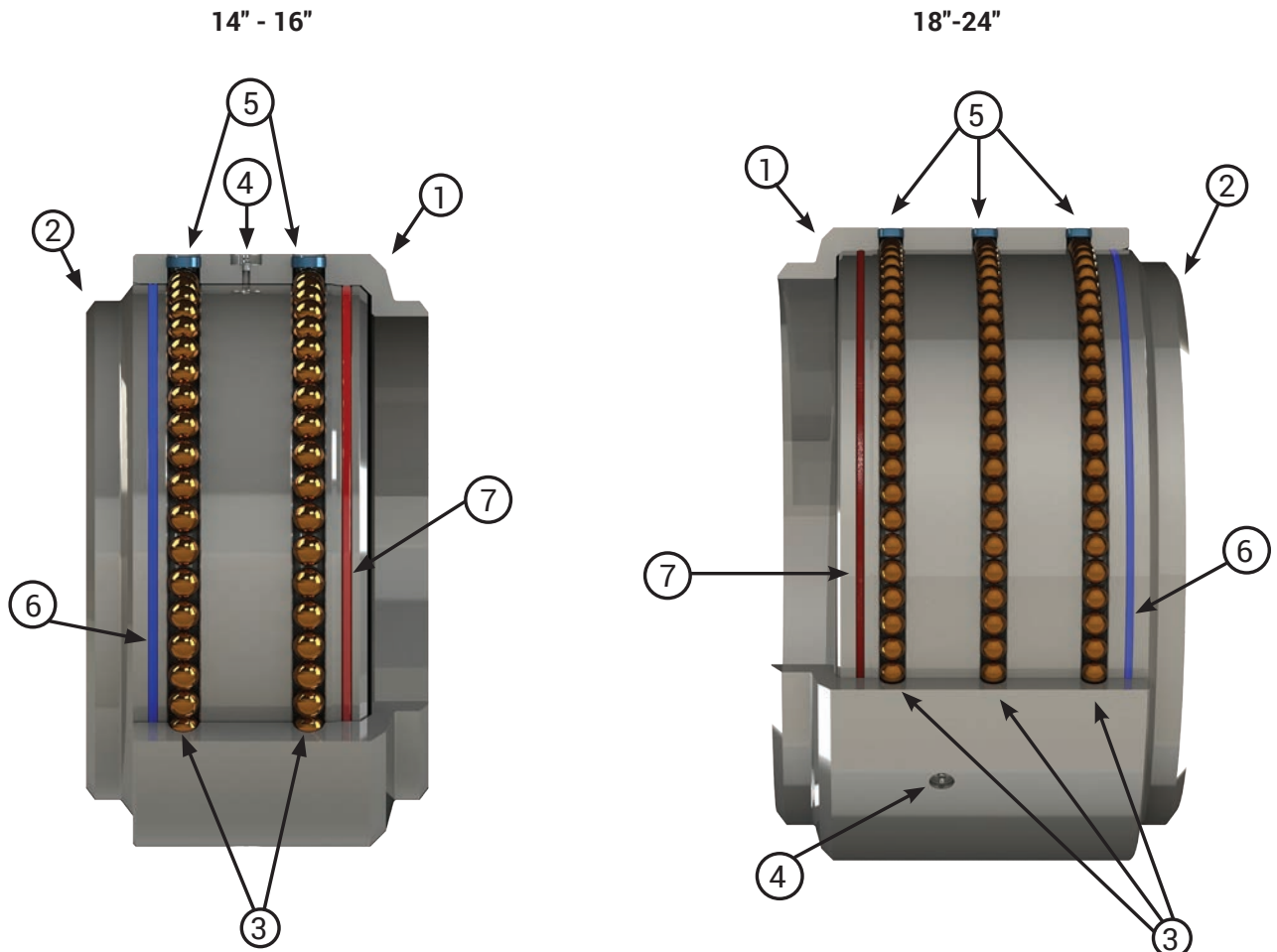

Cap Seal Swivel Joint Numbering System

| 16           | 20    | FG             | FG             | UC                                 | 0                  | 0                  | 0               | 0                       | 0                    |
|--------------|-------|----------------|----------------|------------------------------------|--------------------|--------------------|-----------------|-------------------------|----------------------|
| Sizes Inches | Style | End Connection | End Connection | Material                           | Pressure Seal      | Dust Seal          | Retainers       | Ball Bearings           | Grease               |
| 14 = 14"     | 20    | W (weld)       | W (weld)       | UC = Cap Seal Carbon Steel         | 0 = nitrile rubber | 0 = nitrile rubber | 0 = No retainer | 0 = CS carbon steel     | 0 = lithium          |
| 16 = 16"     | 30    | FG (150#)      | FG (150#)      | US = Cap Seal 316L Stainless Steel | 1 = FKM            | 1 = FKM            |                 | 1 = 440 stainless steel | 1 = food grade steel |
| 18 = 18"     | 40    | PF (300#)      | PF (300#)      |                                    | 5 = No seal        | 5 = No seal        |                 | 2 = 316 stainless steel | 2 = silicone         |
| 20 = 20"     | 50    |                |                |                                    |                    |                    |                 |                         | 3 = Tribolube        |
| 24 = 24"     | 60    |                |                |                                    |                    |                    |                 |                         | 4 = low temperature  |
|              | 70    |                |                |                                    |                    |                    |                 |                         | 5 = no grease        |

NOTE: Other end connections or seals are available upon request.

- Includes standard issue grease fittings without ball check. Ask for ball check if required.

Cap Seal Style 20 - Weld x Weld



| Size | Part #  | Material             | Weight (lbs) | Dimension A |
|------|---------|----------------------|--------------|-------------|
| 14"  | 1420WXW | UC - carbon steel    | 255          | 11-23/32"   |
| 16"  | 1620WXW | UC - carbon steel    | 255          | 10-31/32"   |
|      |         | US - stainless steel | 250          |             |
| 18"  | 1820WXW | UC - carbon steel    | 330          | 12-3/32"    |
|      |         | US - stainless steel | 325          |             |
| 20"  | 2020WXW | UC - carbon steel    | 440          | 14"         |
| 24"  | 2420WXW | UC - carbon steel    | 660          | 16-7/8"     |

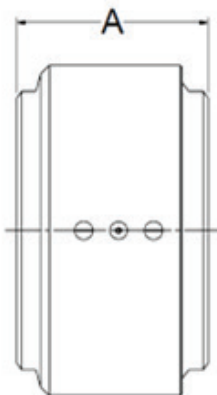



**Cap Seal Style 20 - 150# Flange x 150# Flange**

| Size | Part #   | Material             | Weight (lbs) | Dimension A |
|------|----------|----------------------|--------------|-------------|
| 14"  | 1420FGFG | UC - carbon steel    | 485          | 21-25/32"   |
| 16"  | 1620FGFG | UC - carbon steel    | 545          | 21"         |
|      |          | US - stainless steel | 535          |             |
| 18"  | 1820FGFG | UC - carbon steel    | 670          | 23-3/32"    |
|      |          | US - stainless steel | 660          |             |
| 20"  | 2020FGFG | UC - carbon steel    | 860          | 25-3/8"     |
| 24"  | 2420FGFG | UC - carbon steel    | 1255         | 28-7/8"     |

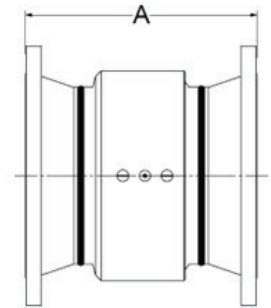

**Cap Seal Style 20 - 300# Flange x 300# Flange**

| Size | Part #   | Material             | Weight (lbs) | Dimension A |
|------|----------|----------------------|--------------|-------------|
| 14"  | 1420PFPF | UC - carbon steel    | 655          | 22-31/32"   |
| 16"  | 1620PFPF | UC - carbon steel    | 755          | 22-15/32"   |
|      |          | US - stainless steel | 745          |             |
| 18"  | 1820PFPF | UC - carbon steel    | 960          | 24-19/32"   |
|      |          | US - stainless steel | 950          |             |
| 20"  | 2020PFPF | UC - carbon steel    | 1205         | 26-3/4"     |
| 24"  | 2420PFPF | UC - carbon steel    | 1790         | 30-1/8"     |

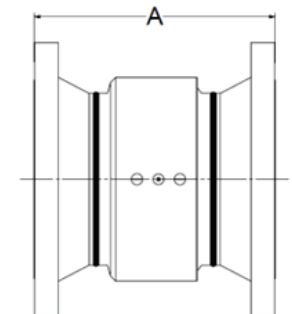
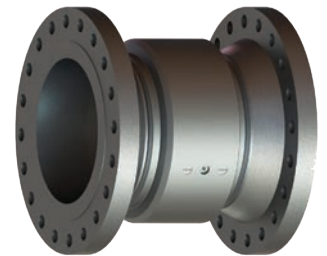

**Cap Seal Style 30 - 150# Flange x 150# Flange**



| Size | Part #   | Material             | Weight (lbs) | Dimensions |           |
|------|----------|----------------------|--------------|------------|-----------|
|      |          |                      |              | A          | B         |
| 14"  | 1430FGFG | UC - carbon steel    | 590          | 30-23/32"  | 19"       |
| 16"  | 1630FGFG | UC - carbon steel    | 680          | 31-31/32"  | 21"       |
|      |          | US - stainless steel | 670          |            |           |
| 18"  | 1830FGFG | UC - carbon steel    | 845          | 35-19/32"  | 23-1/2"   |
|      |          | US - stainless steel | 830          |            |           |
| 20"  | 2030FGFG | UC - carbon steel    | 1080         | 39-11/16"  | 25-11/16" |
| 24"  | 2430FGFG | UC - carbon steel    | 1570         | 46-7/8"    | 30"       |

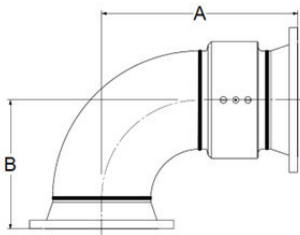

**Cap Seal Style 30 - 300# Flange x 300# Flange**



| Size | Part #   | Material             | Weight (lbs) | Dimensions |         |
|------|----------|----------------------|--------------|------------|---------|
|      |          |                      |              | A          | B       |
| 14"  | 1430PFPF | UC - carbon steel    | 760          | 31-11/32"  | 19-5/8" |
| 16"  | 1630PFPF | UC - carbon steel    | 895          | 32-23/32"  | 21-3/4" |
|      |          | US - stainless steel | 885          |            |         |
| 18"  | 1830PFPF | UC - carbon steel    | 1135         | 36-11/32"  | 24-1/4" |
|      |          | US - stainless steel | 1120         |            |         |
| 20"  | 2030PFPF | UC - carbon steel    | 1425         | 40-3/8"    | 26-3/8" |
| 24"  | 2430PFPF | UC - carbon steel    | 2105         | 30-5/8"    |         |

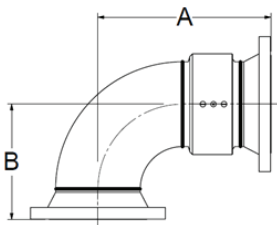

**Cap Seal Style 40 - 150# Flange x 150# Flange**

| Size | Part #   | Material             | Weight (lbs) | Dimensions |           |         |
|------|----------|----------------------|--------------|------------|-----------|---------|
|      |          |                      |              | A          | B         | C       |
| 14"  | 1440FGFG | UC - carbon steel    | 695          | 39-23/32"  | 19"       | 38"     |
| 16"  | 1640FGFG | UC - carbon steel    | 815          | 42-31/32"  | 21"       | 42"     |
|      |          | US - stainless steel | 805          |            |           |         |
| 18"  | 1840FGFG | UC - carbon steel    | 1015         | 48-3/32"   | 23-1/2"   | 47"     |
|      |          | US - stainless steel | 1005         |            |           |         |
| 20"  | 2040FGFG | UC - carbon steel    | 1295         | 54"        | 25-11/16" | 51-3/8" |
| 24"  | 2440FGFG | UC - carbon steel    | 1885         | 64-7/8"    | 30"       | 60"     |

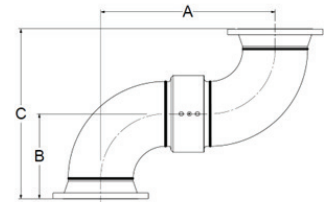

**Cap Seal Style 40 - 300# Flange x 300# Flange**

| Size | Part #   | Material             | Weight (lbs) | Dimensions |         |         |
|------|----------|----------------------|--------------|------------|---------|---------|
|      |          |                      |              | A          | B       | C       |
| 14"  | 1440PFPF | UC - carbon steel    | 870          | 39-23/32"  | 19-5/8" | 39-1/4" |
| 16"  | 1640PFPF | UC - carbon steel    | 1035         | 42-31/32"  | 21-3/4" | 43-1/2" |
|      |          | US - stainless steel | 1020         |            |         |         |
| 18"  | 1840PFPF | UC - carbon steel    | 1315         | 48-3/32"   | 21-1/4" | 48-1/2" |
|      |          | US - stainless steel | 1295         |            |         |         |
| 20"  | 2040PFPF | UC - carbon steel    | 1645         | 54"        | 26-3/8" | 52-3/4" |
| 24"  | 2440PFPF | UC - carbon steel    | 2425         | 64-7/8"    | 30-5/8" | 61-1/4" |

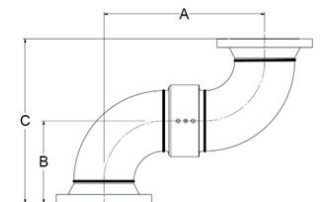

## Cap Seal Swivel Joint Seal Replacement Procedure

**1** Remove the raceway set screws. Rotate the sleeve inside the body, while removing the ball bearings using a magnetic pick-up tool. When all the balls have been removed, the body and sleeve can be separated.



**2** Remove the seals using hand tools that will not damage or scratch the seal grooves. Discard old seals. Thoroughly clean the body, sleeve, and ball bearings using solvent/degreaser.



**3** Apply grease to the dust seal groove, which is the one closest to the weld, using a small chip/paint brush.



**4** Dry wipe the X-ring (quad) dust seal using a shop towel to remove any debris (refer to seal guide). Put the dust seal into the dust seal groove of the swivel sleeve. Inspect the dust seal to make sure there are no twists.



**5** Apply grease to the dust seal and the outside of the swivel sleeve on all surfaces extending from the dust seal groove to the pressure seal groove.



**6** Install the O-ring energizer into the pressure seal groove (Refer to Seal Guide). Inspect the O-ring energizer to make sure it is not twisted and apply grease to the O-ring energizer.



### Cap Seal Swivel Joint Seal Replacement Procedure

**7** Install the cap pressure seal over top of the pressure seal energizer (Refer to seal guide). The small groove faces outward. Metal or sharp tools must not be used to install the cap seal. Apply grease to the cap pressure seal.



**8** Apply grease to the inside of the swivel body on all surfaces extending from the dust seal sealing face to the pressure seal sealing face.

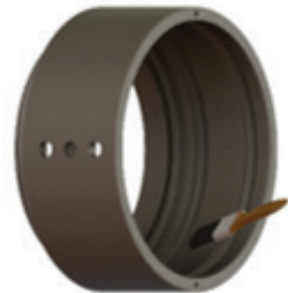

**9** Move the swivel sleeve (or move the swivel body) so that the sleeve and body are concentrically aligned.



**10** Insert the swivel sleeve into the body until the raceways are aligned.



**11** Insert the ball bearings into the raceways while rotating one of the components (body or sleeve).

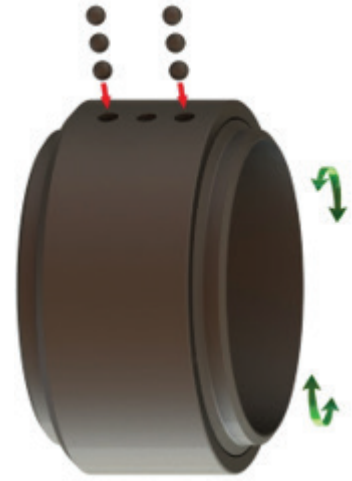

**12** Install the set screws and grease plugs. Add grease into the grease plug, as necessary (application dependent).

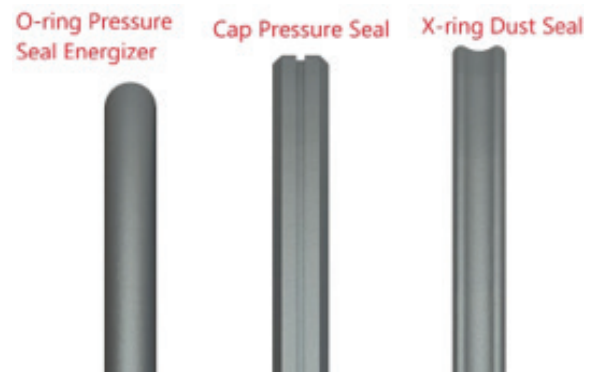

## Split Flange Swivel Joints

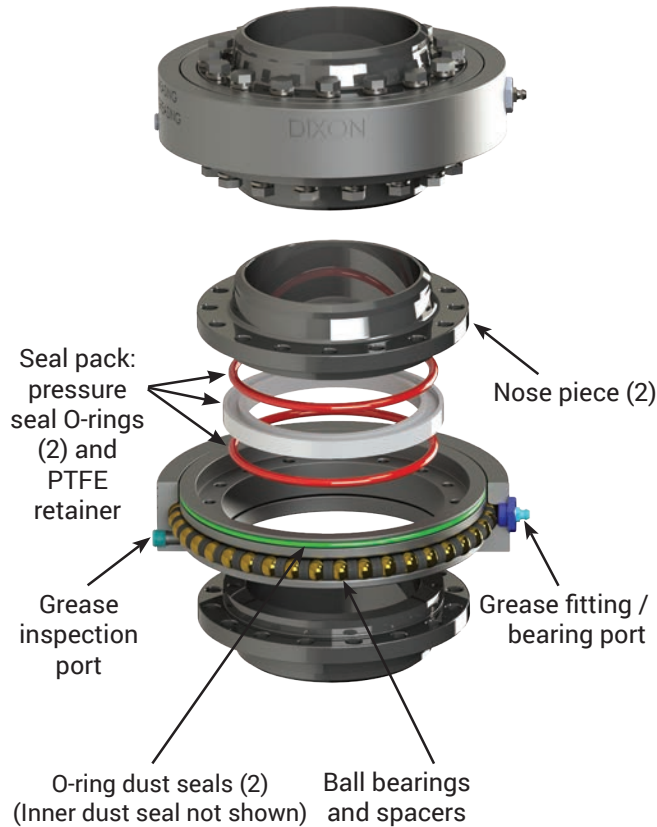

### Applications

- For use in industries from petroleum, blending plants, petrochemical, refining, mining, distilling, paint plants, farm irrigation and fertilizing, wastewater treatment, food and beverage process equipment, marine, and many more

### Sizes

- 2", 3", and 4"

### Features

- Bearing pack design allows easy seal change without removing the ball bearings
- Simple maintenance: remove one nose piece, replace seal pack, and reinstall with little downtime
- In-stream seal separates the wetted area from the ball bearings, allowing for longer bearing pack life compared to conventional swivels
- Single wide-set bearing race for higher moment loads
- Compact design for low-profile applications
- Full penetration weld

### Materials

- Bearing pack: through hardened forged high-carbon alloy
- Material contact surfaces: stainless steel, carbon steel, or aluminum nose pieces
- Seals: Baylast™, FKM, PTFE, and more upon request

### Specifications

- Pressure rating: up to **600 PSI**
- Standard temperature range with Baylast™ seals is **-30°F to 212°F (-34°C to 100°C)**; contact factory for other temperature requirements

### Available options

- Swivel end configurations: 150 lbs. and 300 lbs. flanges, FNPT, MNPT, butt weld, TTMA, and others upon request

## Split Flange Swivel Joint Numbering System

| SF           | 2            | 20    | F              | x | F              | CS                         | 1                      | 1                   |
|--------------|--------------|-------|----------------|---|----------------|----------------------------|------------------------|---------------------|
| Split Flange | Sizes Inches | Style | End Connection | x | End Connection | Nose Piece                 | Seal Material          | Grease              |
| SF           | 2 = 2"       | 20    | F (FNPT)       | x | F (FNPT)       | CS<br>carbon steel         | 0 = Baylast            | 0 = Standard        |
|              | 3 = 3"       | 30    | W (weld)       | x | W (weld)       | SS<br>316L stainless steel | 1 = FKM                | 1 = Food grade      |
|              | 4 = 4"       | 40    | FG (150#)      | x | FG (150#)      | AL - Aluminum              | 2 = PTFE               | 2 = Silicone        |
|              |              | 50    | PF (300#)      | x | PF (300#)      |                            | 3 = EPDM               | 3 = Tribolube       |
|              |              | 60    | TF (TTMA)      | x | TF (TTMA)      |                            | 4 = FDA nitrile rubber | 4 = Low temperature |
|              |              | 70    | BP (BSPP)      | x | BP (BSPP)      |                            | A = low temp FKM       |                     |
|              |              | 80    | BT (BSPT)      | x | BT (BSPT)      |                            |                        |                     |
|              |              | 10    | M (MNPT)       |   | M (MNPT)       |                            |                        |                     |



**Split Flange Style 20 - Weld x Weld**

| Size | Part #   | Material             | Weight (lbs) | Dimension A |
|------|----------|----------------------|--------------|-------------|
| 2"   | SF220WXW | CS - carbon steel    | 13           | 3-7/8"      |
|      |          | SS - stainless steel | 12           |             |
|      |          | AL - aluminum        | 10           |             |
| 3"   | SF320WXW | CS - carbon steel    | 16           | 4-1/32"     |
|      |          | SS - stainless steel | 16           |             |
|      |          | AL - aluminum        | 13           |             |
| 4"   | SF420WXW | CS - carbon steel    | 21           | 3-25/32"    |
|      |          | SS - stainless steel | 20           |             |
|      |          | AL - aluminum        | 16           |             |

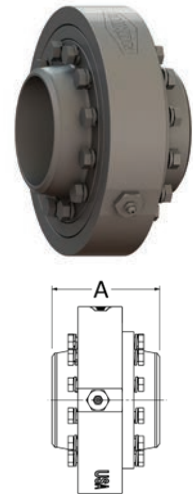

**Split Flange Style - 20 FNPT x FNPT**

| Size | Part #   | Material             | Weight (lbs) | Dimension A |
|------|----------|----------------------|--------------|-------------|
| 2"   | SF220FXF | CS - carbon steel    | 16           | 7-1/4"      |
|      |          | SS - stainless steel | 16           |             |
|      |          | AL - aluminum        | 11           |             |
| 3"   | SF320FXF | CS - carbon steel    | 24           | 8-1/8"      |
|      |          | SS - stainless steel | 23           |             |
|      |          | AL - aluminum        | 15           |             |
| 4"   | SF420FXF | CS - carbon steel    | 34           | 8-1/2"      |
|      |          | SS - stainless steel | 34           |             |
|      |          | AL - aluminum        | 17           |             |

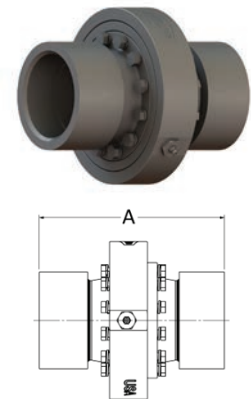

**Split Flange Style 20 - 150# Flange x 150# Flange**

| Size | Part #     | Material             | Weight (lbs) | Dimension A |
|------|------------|----------------------|--------------|-------------|
| 2"   | SF220FGXFG | CS - carbon steel    | 24           | 8-25/32"    |
|      |            | SS - stainless steel | 24           |             |
|      |            | AL - aluminum        | 13           |             |
| 3"   | SF320FGXFG | CS - carbon steel    | 38           | 9-9/16"     |
|      |            | SS - stainless steel | 37           |             |
|      |            | AL - aluminum        | 20           |             |
| 4"   | SF420FGXFG | CS - carbon steel    | 51           | 9-25/32"    |
|      |            | SS - stainless steel | 51           |             |
|      |            | AL - aluminum        | 27           |             |

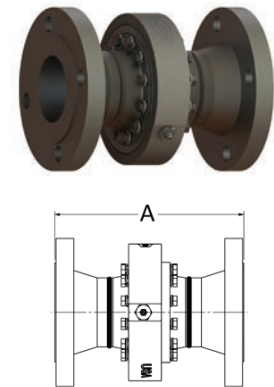

**Split Flange Style 20 - 300# Flange x 300# Flange**

| Size | Part #     | Material             | Weight (lbs) | Dimension A |
|------|------------|----------------------|--------------|-------------|
| 2"   | SF220PFXPF | CS - carbon steel    | 27           | 9-3/8"      |
|      |            | SS - stainless steel | 27           |             |
|      |            | AL - aluminum        | 15           |             |
| 3"   | SF320PFXPF | CS - carbon steel    | 47           | 10-9/32"    |
|      |            | SS - stainless steel | 47           |             |
|      |            | AL - aluminum        | 23           |             |
| 4"   | SF420PFXPF | CS - carbon steel    | 70           | 10-19/32"   |
|      |            | SS - stainless steel | 69           |             |
|      |            | AL - aluminum        | 33           |             |

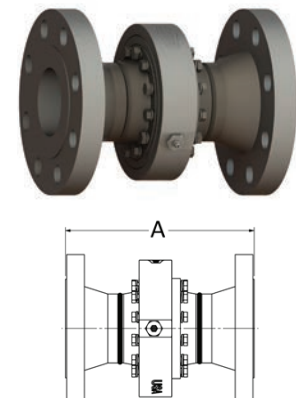

**Split Flange Style 30 - FNPT x FNPT**

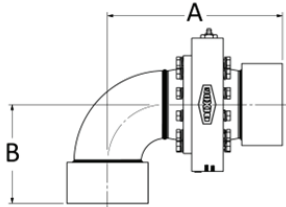

| Size | Part #   | Material             | Weight (lbs) | Dimensions |          |
|------|----------|----------------------|--------------|------------|----------|
|      |          |                      |              | A          | B        |
| 2"   | SF230FXF | CS - carbon steel    | 17           | 8-9/16"    | 4-11/16" |
|      |          | SS - stainless steel | 17           |            |          |
|      |          | AL - aluminum        | 12           |            |          |
| 3"   | SF330FXF | CS - carbon steel    | 26           | 9-5/32"    | 5-1/8"   |
|      |          | SS - stainless steel | 26           |            |          |
|      |          | AL - aluminum        | 16           |            |          |
| 4"   | SF430FXF | CS - carbon steel    | 39           | 10-5/32"   | 6-3/8"   |
|      |          | SS - stainless steel | 39           |            |          |
|      |          | AL - aluminum        | 19           |            |          |

**Split Flange Style 30 - 150# Flange x 150# Flange**

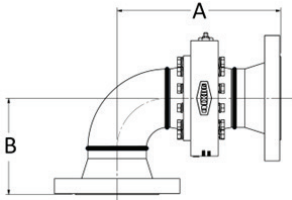

| Size | Part #     | Material             | Weight (lbs) | Dimensions |          |
|------|------------|----------------------|--------------|------------|----------|
|      |            |                      |              | A          | B        |
| 2"   | SF230FGXFG | CS - carbon steel    | 25           | 9-11/32"   | 5-15/32" |
|      |            | SS - stainless steel | 25           |            |          |
|      |            | AL - aluminum        | 14           |            |          |
| 3"   | SF330FGXFG | CS - carbon steel    | 41           | 9-25/32"   | 5-25/32" |
|      |            | SS - stainless steel | 41           |            |          |
|      |            | AL - aluminum        | 21           |            |          |
| 4"   | SF430FGXFG | CS - carbon steel    | 57           | 10-13/16"  | 7-1/32"  |
|      |            | SS - stainless steel | 56           |            |          |
|      |            | AL - aluminum        | 28           |            |          |

**Split Flange Style 30 - 300# Flange x 300# Flange**

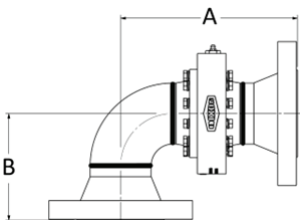

| Size | Part #     | Material             | Weight (lbs) | Dimensions |          |
|------|------------|----------------------|--------------|------------|----------|
|      |            |                      |              | A          | B        |
| 2"   | SF230PFXPF | CS - carbon steel    | 29           | 9-21/32"   | 5-25/32" |
|      |            | SS - stainless steel | 28           |            |          |
|      |            | AL - aluminum        | 16           |            |          |
| 3"   | SF330PFXPF | CS - carbon steel    | 50           | 11-1/32"   | 7-1/32"  |
|      |            | SS - stainless steel | 50           |            |          |
|      |            | AL - aluminum        | 24           |            |          |
| 4"   | SF430PFXPF | CS - carbon steel    | 75           | 11-3/16"   | 7-13/32" |
|      |            | SS - stainless steel | 76           |            |          |
|      |            | AL - aluminum        | 35           |            |          |

**Split Flange Style 40 - FNPT x FNPT**

| Size | Part #   | Material             | Weight (lbs) | Dimensions |          |          |
|------|----------|----------------------|--------------|------------|----------|----------|
|      |          |                      |              | A          | B        | C        |
| 2"   | SF240FXF | CS - carbon steel    | 19           | 9-7/8"     | 4-13/16" | 9-21/32" |
|      |          | SS - stainless steel | 18           |            |          |          |
|      |          | AL - aluminum        | 12           |            |          |          |
| 3"   | SF340FXF | CS - carbon steel    | 29           | 10-1/32"   | 5-1/8"   | 10-1/4"  |
|      |          | SS - stainless steel | 29           |            |          |          |
|      |          | AL - aluminum        | 17           |            |          |          |
| 4"   | SF440FXF | CS - carbon steel    | 45           | 11-25/32"  | 6-3/8"   | 12-3/4"  |
|      |          | SS - stainless steel | 44           |            |          |          |
|      |          | AL - aluminum        | 21           |            |          |          |

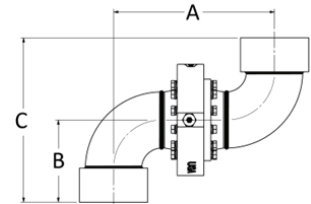

**Split Flange Style 40 - 150# Flange x 150# Flange**

| Size | Part #     | Material             | Weight (lbs) | Dimensions |          |           |
|------|------------|----------------------|--------------|------------|----------|-----------|
|      |            |                      |              | A          | B        | C         |
| 2"   | SF240FGXFG | CS - carbon steel    | 26           | 9-7/8"     | 5-15/32" | 10-29/32" |
|      |            | SS - stainless steel | 26           |            |          |           |
|      |            | AL - aluminum        | 16           |            |          |           |
| 3"   | SF340FGXFG | CS - carbon steel    | 44           | 10-1/32"   | 5-3/4"   | 11-1/2"   |
|      |            | SS - stainless steel | 43           |            |          |           |
|      |            | AL - aluminum        | 22           |            |          |           |
| 4"   | SF440FGXFG | CS - carbon steel    | 62           | 11-25/32"  | 7"       | 14"       |
|      |            | SS - stainless steel | 62           |            |          |           |
|      |            | AL - aluminum        | 30           |            |          |           |

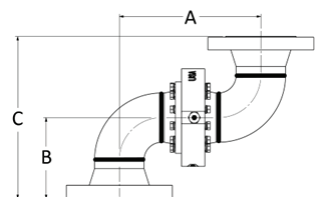

**Split Flange Style 40 - 300# Flange x 300# Flange**

| Size | Part #     | Material             | Weight (lbs) | Dimensions |        |         |
|------|------------|----------------------|--------------|------------|--------|---------|
|      |            |                      |              | A          | B      | C       |
| 2"   | SF240PFXPF | CS - carbon steel    | 30           | 9-7/8"     | 5-3/4" | 11-1/2" |
|      |            | SS - stainless steel | 30           |            |        |         |
|      |            | AL - aluminum        | 16           |            |        |         |
| 3"   | SF340PFXPF | CS - carbon steel    | 53           | 10-1/32"   | 6-1/8" | 12-1/4" |
|      |            | SS - stainless steel | 53           |            |        |         |
|      |            | AL - aluminum        | 25           |            |        |         |
| 4"   | SF440PFXPF | CS - carbon steel    | 81           | 11-25/32"  | 7-3/8" | 14-3/4" |
|      |            | SS - stainless steel | 80           |            |        |         |
|      |            | AL - aluminum        | 37           |            |        |         |

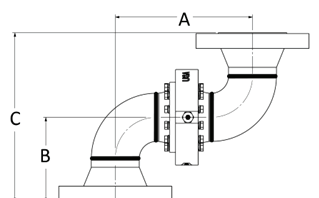

**Split Flange Style 50 - FNPT x FNPT**

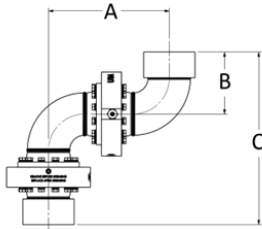

| Size | Part #   | Material             | Weight (lbs) | Dimensions |          |          |
|------|----------|----------------------|--------------|------------|----------|----------|
|      |          |                      |              | A          | B        | C        |
| 2"   | SF250FXF | CS - carbon steel    | 31           | 9-7/8"     | 4-11/16" | 13-1/4"  |
|      |          | SS - stainless steel | 31           |            |          |          |
|      |          | AL - aluminum        | 22           |            |          |          |
| 3"   | SF350FXF | CS - carbon steel    | 46           | 10-1/32"   | 5-1/8"   | 14-9/32" |
|      |          | SS - stainless steel | 45           |            |          |          |
|      |          | AL - aluminum        | 30           |            |          |          |
| 4"   | SF450FXF | CS - carbon steel    | 65           | 11-25/32"  | 6-3/8"   | 16-1/2"  |
|      |          | SS - stainless steel | 65           |            |          |          |
|      |          | AL - aluminum        | 37           |            |          |          |

**Split Flange Style 50 - 150# Flange x 150# Flange**

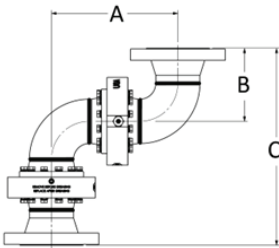

| Size | Part #     | Material             | Weight (lbs) | Dimensions |        |           |
|------|------------|----------------------|--------------|------------|--------|-----------|
|      |            |                      |              | A          | B      | C         |
| 2"   | SF250FGXFG | CS - carbon steel    | 39           | 9-7/8"     | 5-1/2" | 14-7/8"   |
|      |            | SS - stainless steel | 38           |            |        |           |
|      |            | AL - aluminum        | 24           |            |        |           |
| 3"   | SF350FGXFG | CS - carbon steel    | 60           | 10-1/32"   | 5-3/4" | 15-17/32" |
|      |            | SS - stainless steel | 59           |            |        |           |
|      |            | AL - aluminum        | 35           |            |        |           |
| 4"   | SF450FGXFG | CS - carbon steel    | 82           | 11-25/32"  | 7"     | 17-25/32" |
|      |            | SS - stainless steel | 82           |            |        |           |
|      |            | AL - aluminum        | 46           |            |        |           |

**Split Flange Style 50 - 300# Flange x 300# Flange**

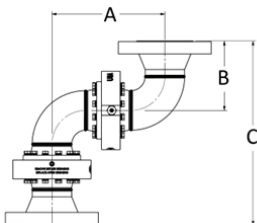

| Size | Part #     | Material             | Weight (lbs) | Dimensions |        |           |
|------|------------|----------------------|--------------|------------|--------|-----------|
|      |            |                      |              | A          | B      | C         |
| 2"   | SF250PFXPF | CS - carbon steel    | 42           | 9-7/8"     | 5-3/4" | 15-3/8"   |
|      |            | SS - stainless steel | 42           |            |        |           |
|      |            | AL - aluminum        | 26           |            |        |           |
| 3"   | SF350PFXPF | CS - carbon steel    | 69           | 10-1/32"   | 6-1/8" | 16-9/32"  |
|      |            | SS - stainless steel | 69           |            |        |           |
|      |            | AL - aluminum        | 38           |            |        |           |
| 4"   | SF450PFXPF | CS - carbon steel    | 101          | 11-25/32"  | 7-3/8" | 18-17/32" |
|      |            | SS - stainless steel | 100          |            |        |           |
|      |            | AL - aluminum        | 52           |            |        |           |

**Split Flange Style 60 - FNPT x FNPT**

| Size | Part #   | Material             | Weight (lbs) | Dimension A |
|------|----------|----------------------|--------------|-------------|
| 2"   | SF260FXF | CS - carbon steel    | 30           | 8-5/8"      |
|      |          | SS - stainless steel | 30           |             |
|      |          | AL - aluminum        | 22           |             |
| 3"   | SF360FXF | CS - carbon steel    | 43           | 9-5/32"     |
|      |          | SS - stainless steel | 43           |             |
|      |          | AL - aluminum        | 29           |             |
| 4"   | SF460FXF | CS - carbon steel    | 60           | 10-1/8"     |
|      |          | SS - stainless steel | 59           |             |
|      |          | AL - aluminum        | 35           |             |

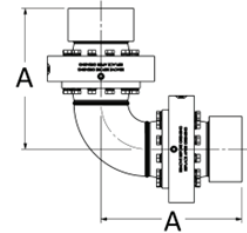

**Split Flange Style 60 - 150# Flange x 150# Flange**

| Size | Part #     | Material             | Weight (lbs) | Dimension A |
|------|------------|----------------------|--------------|-------------|
| 2"   | SF260FGXFG | CS - carbon steel    | 37           | 9-3/8"      |
|      |            | SS - stainless steel | 38           |             |
|      |            | AL - aluminum        | 24           |             |
| 3"   | SF360FGXFG | CS - carbon steel    | 57           | 9-25/32"    |
|      |            | SS - stainless steel | 57           |             |
|      |            | AL - aluminum        | 34           |             |
| 4"   | SF460FGXFG | CS - carbon steel    | 77           | 10-3/4"     |
|      |            | SS - stainless steel | 77           |             |
|      |            | AL - aluminum        | 44           |             |

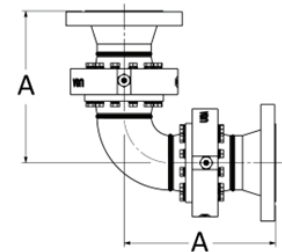

**Split Flange Style 60 - 300# Flange x 300# Flange**

| Size | Part #    | Material             | Weight (lbs) | Dimension A |
|------|-----------|----------------------|--------------|-------------|
| 2"   | SF260PFXP | CS - carbon steel    | 41           | 9-5/8"      |
|      |           | SS - stainless steel | 41           |             |
|      |           | AL - aluminum        | 26           |             |
| 3"   | SF360PFXP | CS - carbon steel    | 66           | 10-5/32"    |
|      |           | SS - stainless steel | 66           |             |
|      |           | AL - aluminum        | 37           |             |
| 4"   | SF460PFXP | CS - carbon steel    | 96           | 11-1/8"     |
|      |           | SS - stainless steel | 95           |             |
|      |           | AL - aluminum        | 50           |             |

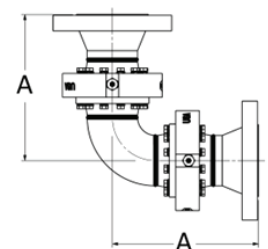

**Split Flange Style 70 - FNPT x FNPT**

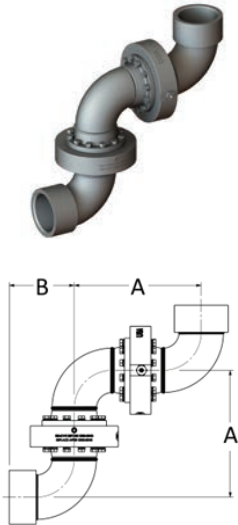

| Size | Part #   | Material             | Weight (lbs) | Dimensions |          |
|------|----------|----------------------|--------------|------------|----------|
|      |          |                      |              | A          | B        |
| 2"   | SF270FXF | CS - carbon steel    | 33           | 9-7/8"     | 4-11/16" |
|      |          | SS - stainless steel | 32           |            |          |
|      |          | AL - aluminum        | 23           |            |          |
| 3"   | SF370FXF | CS - carbon steel    | 49           | 10-1/32"   | 5-1/8"   |
|      |          | SS - stainless steel | 48           |            |          |
|      |          | AL - aluminum        | 31           |            |          |
| 4"   | SF470FXF | CS - carbon steel    | 71           | 11-25/32"  | 6-3/8"   |
|      |          | SS - stainless steel | 70           |            |          |
|      |          | AL - aluminum        | 39           |            |          |

**Split Flange Style 70 - 150# Flange x 150# Flange**

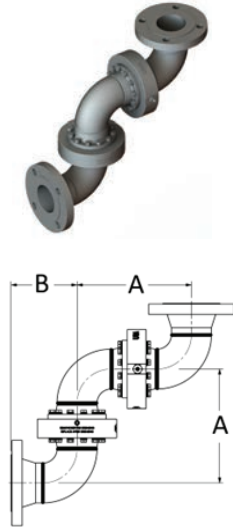

| Size | Part #     | Material             | Weight (lbs) | Dimensions |          |
|------|------------|----------------------|--------------|------------|----------|
|      |            |                      |              | A          | B        |
| 2"   | SF270FGXFG | CS - carbon steel    | 41           | 9-7/8"     | 5-1/2"   |
|      |            | SS - stainless steel | 40           |            |          |
|      |            | AL - aluminum        | 25           |            |          |
| 3"   | SF370FGXFG | CS - carbon steel    | 63           | 10-1/32"   | 5-25/32" |
|      |            | SS - stainless steel | 62           |            |          |
|      |            | AL - aluminum        | 36           |            |          |
| 4"   | SF470FGXFG | CS - carbon steel    | 88           | 11-25/32"  | 7"       |
|      |            | SS - stainless steel | 88           |            |          |
|      |            | AL - aluminum        | 48           |            |          |

**Split Flange Style 70 - 300# Flange x 300# Flange**

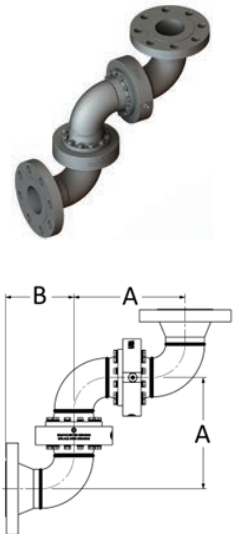

| Size | Part #     | Material             | Weight (lbs) | Dimensions |          |
|------|------------|----------------------|--------------|------------|----------|
|      |            |                      |              | A          | B        |
| 2"   | SF270PFXPF | CS - carbon steel    | 44           | 9-7/8"     | 5-1/2"   |
|      |            | SS - stainless steel | 44           |            |          |
|      |            | AL - aluminum        | 27           |            |          |
| 3"   | SF370PFXPF | CS - carbon steel    | 72           | 10-1/32"   | 5-25/32" |
|      |            | SS - stainless steel | 72           |            |          |
|      |            | AL - aluminum        | 39           |            |          |
| 4"   | SF470PFXPF | CS - carbon steel    | 106          | 11-25/32"  | 7-3/8"   |
|      |            | SS - stainless steel | 106          |            |          |
|      |            | AL - aluminum        | 54           |            |          |

## Split Flange Swivel Components

### Bearing Packs

**Feature**

- Single wide-set bearing race for high moment loads

**Materials**

- Through hardened forged carbon steel
- Carbon steel ball bearings
- FKM dust seals



| Size | Part # |
|------|--------|
| 2"   | 2SFBP  |
| 3"   | 3SFBP  |
| 4"   | 4SFBP  |

### Nose Pieces

**Feature**

- 2 required per bearing pack

| Size | Aluminum Part # | Carbon Steel Part # | 316 Stainless Steel Part # |
|------|-----------------|---------------------|----------------------------|
| 2"   | 2SFNPAL         | 2SFNPCS             | 2SFNPSS                    |
| 3"   | 3SFNPAL         | 3SFNPCS             | 3SFNPSS                    |
| 4"   | 4SFNPAL         | 4SFNPCS             | 4SFNPSS                    |



### Seal Kits

**Features**

- Kits contain: seals, PTFE retainer, carbon steel bolts, and lock washers
- 1 required per bearing pack

| Size | Baylast™ Part # | FKM Part # | PTFE Part # | EPDM Part # | Low Temperature FKM Part # | FDA Nitrile Rubber Part # |
|------|-----------------|------------|-------------|-------------|----------------------------|---------------------------|
| 2"   | 2SFSK-BAYLAST   | 2SFSK-VI   | 2SFSK-TES   | 2SFSK-EP    | 2SFSK-VM125-75             | 2SFSK-FB                  |
| 3"   | 3SFSK-BAYLAST   | 3SFSK-VI   | 3SFSK-TES   | 3SFSK-EP    | 3SFSK-VM125-75             | 3SFSK-FB                  |
| 4"   | 4SFSK-BAYLAST   | 4SFSK-VI   | 4SFSK-TES   | 4SFSK-EP    | 4SFSK-VM125-75             | 4SFSK-FB                  |



## Split Flange Swivel Locking Kits

**Applications**

- Locks the swivel into a horizontal position
- Not to be used vertically

**Feature**

- Single or multiple hole design

**Material**

- Carbon steel

| Size  | Description   | Part #          |
|-------|---|-----------------|
| 2"    | locking multiple hole T-handle kit for split flange swivel joints | LA-2SFLOCKTHK-M |
| 3"/4" | locking single hole T-handle kit for split flange swivel joints   | LA-SFLOCKTHK-S  |
|       | locking multiple hole T-handle kit for split flange swivel joints | LA-SFLOCKTHK-M  |



**Warning:** This item is only intended to restrain the rotation during storage and is limited to a maximum of 12 in-lbs. of torque.



### Split Flange Swivel Joint Seal Replacement Procedure

To change the seals in a Dixon® split flange swivel joint you will need the following items:

- 1/2" wrench or socket wrench with 1/2" sockets
- Torque wrench
- Application-appropriate grease
- Repair kit

**1** Follow your company guidelines to properly shut down the system and confirm there is no residual pressure in the line. Support or remove any components necessary to disconnect at least one nose piece.

**2** Remove all the bolts and washers from one of the nose pieces. Pick the side that gives the best access to the seal gland.

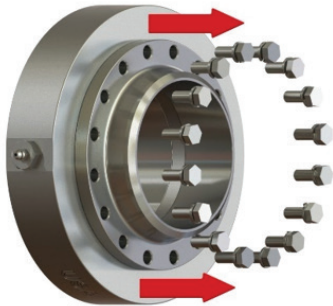

**3a** Remove and discard the old O-rings and PTFE H-ring. Clean the seal gland area.

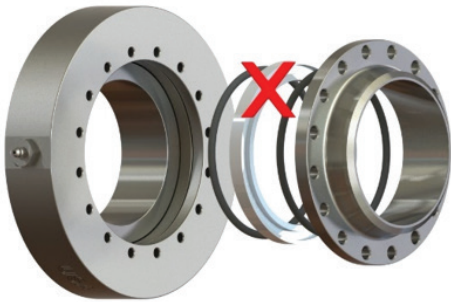

**3b** Lubricate the body and sleeve, new H-ring and O-rings with grease.

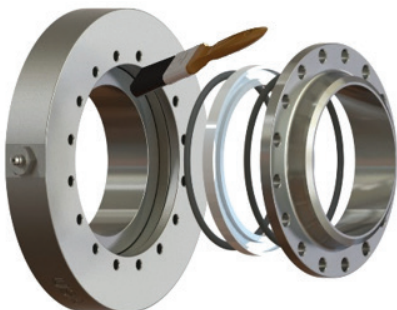

**4** Install the replacement O-rings and the new H-ring. Make sure the O-rings are set in on each side of the H-ring. Be careful not to pinch the O-rings during reassembly.



**5** Reinstall the nose piece using the new bolts and washers in the replacement kit. Do not reuse old bolts and washers.

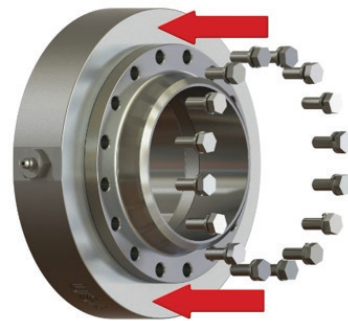

**6** Torque the bolts to 25 ft-lbs. in a star pattern

Pressure testing is recommended prior to returning the swivel joint to service. If needed, this is a good time to clean and repaint any carbon steel parts to help protect them from the elements.

Once the seal replacement and pressure testing are complete the unit can be returned to service.

## High Capacity Swivel Joints

New

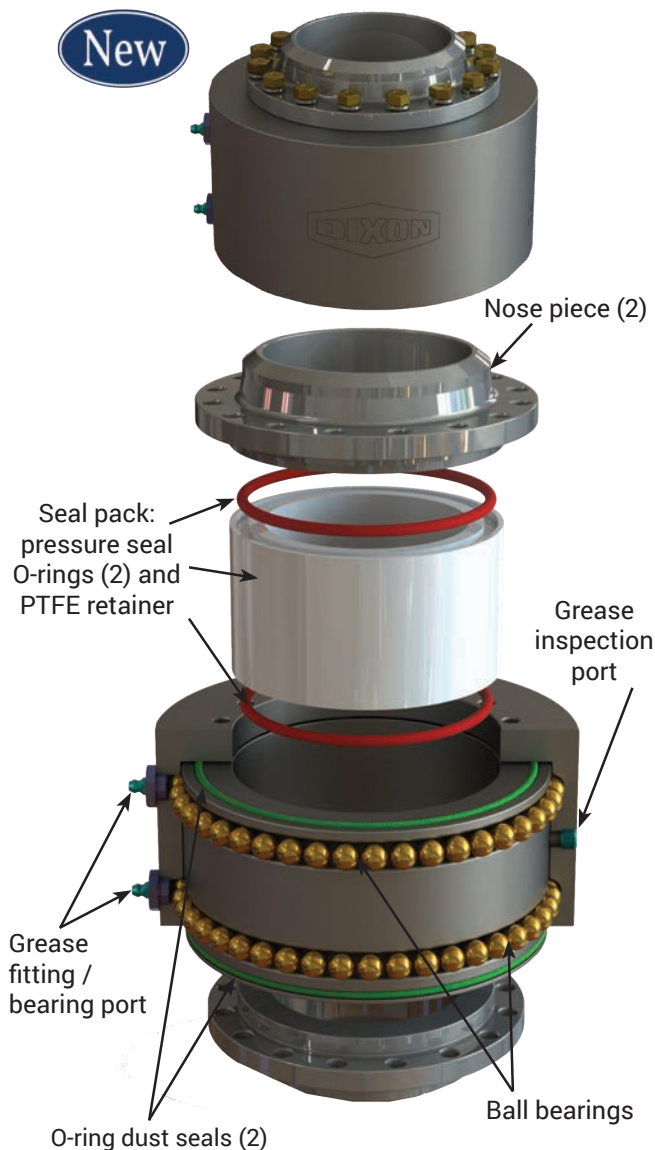

### Applications

- For use in industries from petroleum, steel producing, blending plants, petrochemical, refining, mining, distilling, paint plants, farm irrigation and fertilizing, wastewater treatment, food and beverage process equipment, marine, and many more
- Ideal for high moment load applications on loading arms

### Sizes

- 2", 3", and 4"

### Features

- Bearing pack design allows easy seal change without removing the ball bearings
- Simple maintenance: remove one nose piece, replace seal pack, and reinstall with little downtime
- In-stream seal separates the wetted area from the ball bearings, allowing for longer bearing pack life compared to conventional swivels
- Dual wide-set bearing race and high strength bolts for higher moment loads
- Compact design for low-profile applications
- Full penetration weld

### Materials

- Bearing pack: through hardened forged high-carbon alloy
- Material contact surfaces: stainless steel, carbon steel nose pieces
- Seals: Baylast™, FKM, PTFE, and more upon request

### Specifications

- Pressure rating: up to **1,000 PSI**
- Standard temperature range with Baylast™ seals is **-30°F to 212°F (-34°C to 100°C)**; contact factory for other temperature requirements

### Available options

- Swivel end configurations: 150 lbs. and 300 lbs. flanges, FNPT, MNPT, butt weld, TTMA, and others upon request

## High Capacity Swivel Joints Numbering System

| HC            | 2            | 20    | F              | x | F              | CS                         | 1                      | 1                   |
|---------------|--------------|-------|----------------|---|----------------|----------------------------|------------------------|---------------------|
| High Capacity | Sizes Inches | Style | End Connection | x | End Connection | Nose Piece                 | Seal Material          | Grease              |
| HC            | 2 = 2"       | 20    | F (FNPT)       | x | F (FNPT)       | CS<br>carbon steel         | 0 = Baylast            | 0 = Standard        |
|               | 3 = 3"       | 30    | W (weld)       | x | W (weld)       | SS<br>316L stainless steel | 1 = FKM                | 1 = Food grade      |
|               | 4 = 4"       | 40    | FG (150#)      | x | FG (150#)      |                            | 2 = PTFE               | 2 = Silicone        |
|               |              | 50    | PF (300#)      | x | PF (300#)      |                            | 3 = EPDM               | 3 = Tribolube       |
|               |              | 60    | TF (TTMA)      | x | TF (TTMA)      |                            | 4 = FDA nitrile rubber | 4 = Low temperature |
|               |              | 70    | BP (BSPP)      | x | BP (BSPP)      |                            | A = low temp FKM       |                     |
|               |              | 80    | BT (BSPT)      | x | BT (BSPT)      |                            |                        |                     |
|               |              | 10    | M (MNPT)       |   | M (MNPT)       |                            |                        |                     |

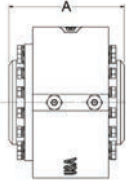

### High Capacity Split Flange Style 20 - Weld x Weld

| Size | Part #   | Material             |
|------|----------|----------------------|
| 2"   | HC220WXW | CS - carbon steel    |
|      |          | SS - stainless steel |
| 3"   | HC320WXW | CS - carbon steel    |
|      |          | SS - stainless steel |
| 4"   | HC420WXW | CS - carbon steel    |
|      |          | SS - stainless steel |

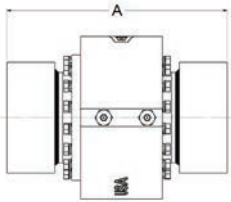

### High Capacity Split Flange Style 20 - FNPT x FNPT

| Size | Part #   | Material             |
|------|----------|----------------------|
| 2"   | HC220FXF | CS - carbon steel    |
|      |          | SS - stainless steel |
| 3"   | HC320FXF | CS - carbon steel    |
|      |          | SS - stainless steel |
| 4"   | HC420FXF | CS - carbon steel    |
|      |          | SS - stainless steel |

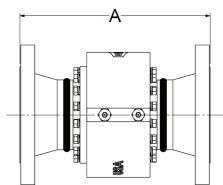
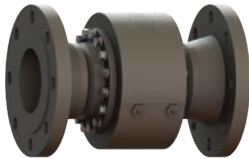

### High Capacity Split Flange Style 20 - 150# Flange x 150# Flange

| Size | Part #     | Material             |
|------|------------|----------------------|
| 2"   | HC220FGXFG | CS - carbon steel    |
|      |            | SS - stainless steel |
| 3"   | HC320FGXFG | CS - carbon steel    |
|      |            | SS - stainless steel |
| 4"   | HC420FGXFG | CS - carbon steel    |
|      |            | SS - stainless steel |

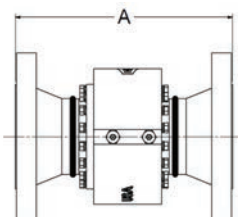
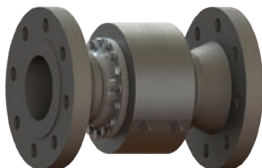

### High Capacity Style 20 - 300# Flange x 300# Flange

| Size | Part #     | Material             |
|------|------------|----------------------|
| 2"   | HC220PFXPF | CS - carbon steel    |
|      |            | SS - stainless steel |
| 3"   | HC320PFXPF | CS - carbon steel    |
|      |            | SS - stainless steel |
| 4"   | HC420PFXPF | CS - carbon steel    |
|      |            | SS - stainless steel |

NOTE: Contact factory for weights and dimensions

## High Capacity Split Flange Style 30 - FNPT x FNPT

| Size | Part #   | Material             |
|------|----------|----------------------|
| 2"   | HC230FXF | CS - carbon steel    |
|      |          | SS - stainless steel |
| 3"   | HC330FXF | CS - carbon steel    |
|      |          | SS - stainless steel |
| 4"   | HC430FXF | CS - carbon steel    |
|      |          | SS - stainless steel |

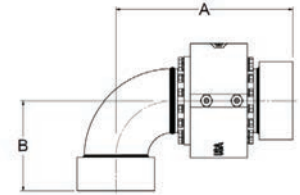

## High Capacity Split Flange Style 30 - 150# Flange x 150# Flange

| Size | Part #     | Material             |
|------|------------|----------------------|
| 2"   | HC230FGXFG | CS - carbon steel    |
|      |            | SS - stainless steel |
| 3"   | HC330FGXFG | CS - carbon steel    |
|      |            | SS - stainless steel |
| 4"   | HC430FGXFG | CS - carbon steel    |
|      |            | SS - stainless steel |

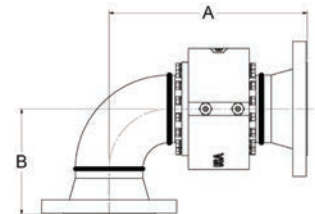

## High Capacity Split Flange Style 30 - 300# Flange x 300# Flange

| Size | Part #     | Material             |
|------|------------|----------------------|
| 2"   | HC230PFXPF | CS - carbon steel    |
|      |            | SS - stainless steel |
| 3"   | HC330PFXPF | CS - carbon steel    |
|      |            | SS - stainless steel |
| 4"   | HC430PFXPF | CS - carbon steel    |
|      |            | SS - stainless steel |

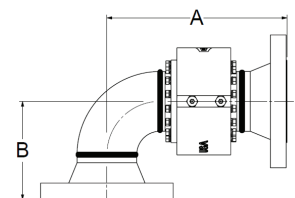

NOTE: Contact factory for weights and dimensions

**High Capacity Split Flange Style 40 - FNPT x FNPT**

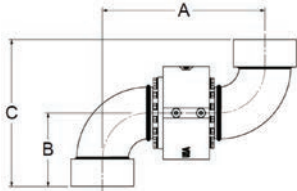

| Size | Part #   | Material             |
|------|----------|----------------------|
| 2"   | HC240FXF | CS - carbon steel    |
|      |          | SS - stainless steel |
| 3"   | HC340FXF | CS - carbon steel    |
|      |          | SS - stainless steel |
| 4"   | HC440FXF | CS - carbon steel    |
|      |          | SS - stainless steel |

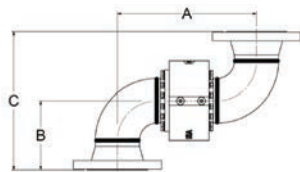

**High Capacity Split Flange Style 40 - 150# Flange x 150# Flange**

| Size | Part #     | Material             |
|------|------------|----------------------|
| 2"   | HC240FGXFG | CS - carbon steel    |
|      |            | SS - stainless steel |
| 3"   | HC340FGXFG | CS - carbon steel    |
|      |            | SS - stainless steel |
| 4"   | HC440FGXFG | CS - carbon steel    |
|      |            | SS - stainless steel |

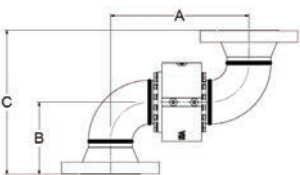

**High Capacity Split Flange Style 40 - 300# Flange x 300# Flange**

| Size | Part #     | Material             |
|------|------------|----------------------|
| 2"   | HC240PFXPF | CS - carbon steel    |
|      |            | SS - stainless steel |
| 3"   | HC340PFXPF | CS - carbon steel    |
|      |            | SS - stainless steel |
| 4"   | HC440PFXPF | CS - carbon steel    |
|      |            | SS - stainless steel |

NOTE: Contact factory for weights and dimensions

## High Capacity Split Flange Style 50 - FNPT x FNPT

| Size | Part #   | Material             |
|------|----------|----------------------|
| 2"   | HC250FXF | CS - carbon steel    |
|      |          | SS - stainless steel |
| 3"   | HC350FXF | CS - carbon steel    |
|      |          | SS - stainless steel |
| 4"   | HC450FXF | CS - carbon steel    |
|      |          | SS - stainless steel |

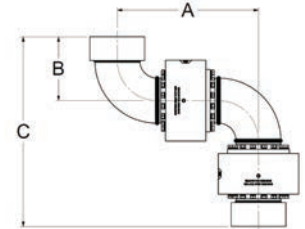

## High Capacity Split Flange Style 50 - 150# Flange x 150# Flange

| Size | Part #     | Material             |
|------|------------|----------------------|
| 2"   | HC250FGXFG | CS - carbon steel    |
|      |            | SS - stainless steel |
| 3"   | HC350FGXFG | CS - carbon steel    |
|      |            | SS - stainless steel |
| 4"   | HC450FGXFG | CS - carbon steel    |
|      |            | SS - stainless steel |

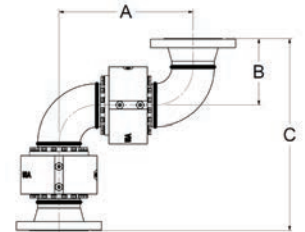

## High Capacity Split Flange Style 50 - 300# Flange x 300# Flange

| Size | Part #     | Material             |
|------|------------|----------------------|
| 2"   | HC250PFXPF | CS - carbon steel    |
|      |            | SS - stainless steel |
| 3"   | HC350PFXPF | CS - carbon steel    |
|      |            | SS - stainless steel |
| 4"   | HC450PFXPF | CS - carbon steel    |
|      |            | SS - stainless steel |

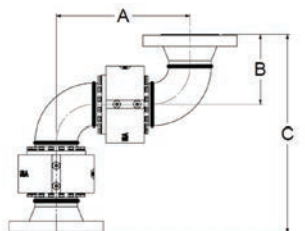

NOTE: Contact factory for weights and dimensions



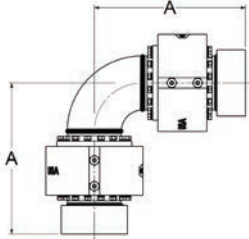

**High Capacity Split Flange Style 60 - FNPT x FNPT**

| Size | Part #   | Material             |
|------|----------|----------------------|
| 2"   | HC260FXF | CS - carbon steel    |
|      |          | SS - stainless steel |
| 3"   | HC360FXF | CS - carbon steel    |
|      |          | SS - stainless steel |
| 4"   | HC460FXF | CS - carbon steel    |
|      |          | SS - stainless steel |

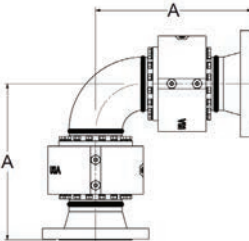

**High Capacity Split Flange Style 60 - 150# Flange x 150# Flange**

| Size | Part #     | Material             |
|------|------------|----------------------|
| 2"   | HC260FGXFG | CS - carbon steel    |
|      |            | SS - stainless steel |
| 3"   | HC360FGXFG | CS - carbon steel    |
|      |            | SS - stainless steel |
| 4"   | HC460FGXFG | CS - carbon steel    |
|      |            | SS - stainless steel |

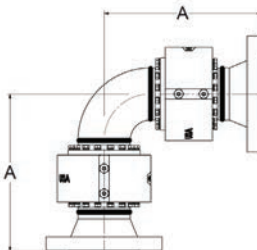

**High Capacity Split Flange Style 60 - 300# Flange x 300# Flange**

| Size | Part #     | Material             |
|------|------------|----------------------|
| 2"   | HC260PFXPF | CS - carbon steel    |
|      |            | SS - stainless steel |
| 3"   | HC360PFXPF | CS - carbon steel    |
|      |            | SS - stainless steel |
| 4"   | HC460PFXPF | CS - carbon steel    |
|      |            | SS - stainless steel |

NOTE: Contact factory for weights and dimensions



## High Capacity Split Flange Style 70 - FNPT x FNPT

| Size | Part #   | Material             |
|------|----------|----------------------|
| 2"   | HC270FXF | CS - carbon steel    |
|      |          | SS - stainless steel |
| 3"   | HC370FXF | CS - carbon steel    |
|      |          | SS - stainless steel |
| 4"   | HC470FXF | CS - carbon steel    |
|      |          | SS - stainless steel |

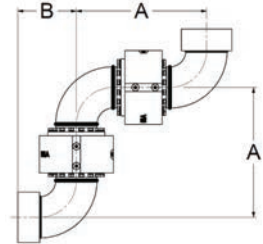

## High Capacity Split Flange Style 70 - 150# Flange x 150# Flange

| Size | Part #     | Material             |
|------|------------|----------------------|
| 2"   | HC270FGXFG | CS - carbon steel    |
|      |            | SS - stainless steel |
| 3"   | HC370FGXFG | CS - carbon steel    |
|      |            | SS - stainless steel |
| 4"   | HC470FGXFG | CS - carbon steel    |
|      |            | SS - stainless steel |

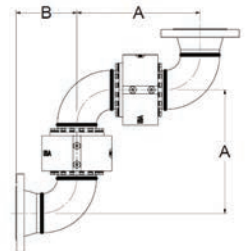

## High Capacity Split Flange Style 70 - 300# Flange x 300# Flange

| Size | Part #     | Material             |
|------|------------|----------------------|
| 2"   | HC270PFXPF | CS - carbon steel    |
|      |            | SS - stainless steel |
| 3"   | HC370PFXPF | CS - carbon steel    |
|      |            | SS - stainless steel |
| 4"   | HC470PFXPF | CS - carbon steel    |
|      |            | SS - stainless steel |

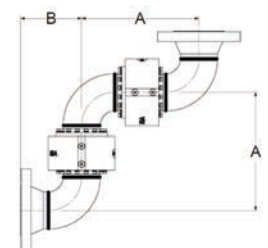

NOTE: Contact factory for weights and dimensions

## High Capacity Split Flange Swivel Components

### Bearing Packs



#### Feature

- Dual wide-set bearing race for higher moment loads

#### Materials

- Through hardened forged carbon steel
- Carbon steel ball bearings
- FKM dust seals

| Size | Part # |
|------|--------|
| 2"   | 2HCBP  |
| 3"   | 3HCBP  |
| 4"   | 4HCBP  |

### Nose Pieces

#### Features

- 2 required per bearing pack
- Sch 80 butt weld ends



#### Material

- Carbon steel and 316 stainless steel

| Size | Carbon Steel Part # | 316 Stainless Steel Part # |
|------|---------------------|----------------------------|
| 2"   | 2HCNPCS             | 2HCNPSS                    |
| 3"   | 3HCNPCS             | 3HCNPSS                    |
| 4"   | 4HCNPCS             | 4HCNPSS                    |

### Seal Kits

#### Features

- Kits contain: seals, PTFE retainer, carbon steel bolts, and lock washers
- 1 required per bearing pack



| Size | Baylast™ Part # | FKM Part # | PTFE Part # | EPDM Part # | FDA Nitrile Rubber Part # |
|------|-----------------|------------|-------------|-------------|---------------------------|
| 2"   | 2HCSK-BAYLAST   | 2HCSK-VI   | 2HCSK-TESS  | 2HCSK-EP    | 2HCSK-FB                  |
| 3"   | 3HCSK-BAYLAST   | 3HCSK-VI   | 3HCSK-TESS  | 3HCSK-EP    | 3HCSK-FB                  |
| 4"   | 4HCSK-BAYLAST   | 4HCSK-VI   | 4HCSK-TESS  | 4HCSK-EP    | 4HCSK-FB                  |

## High-Capacity Swivel Joint Seal Replacement Procedure

To change the seals in a Dixon® split flange swivel joint you will need the following items:

- 1/2" wrench or socket wrench with 1/2" socket
- Torque wrench
- Application-appropriate grease
- Repair kit

**1** Follow your company guidelines to properly shut down the system and confirm there is no residual pressure in the line. Support or remove any components necessary to disconnect at least one nose piece.

**2** Remove all the bolts and washers from one of the nose pieces. Pick the side that gives the best access to the seal gland.



**3** Remove and discard the old O-rings and PTFE H-ring. Clean the seal gland area.

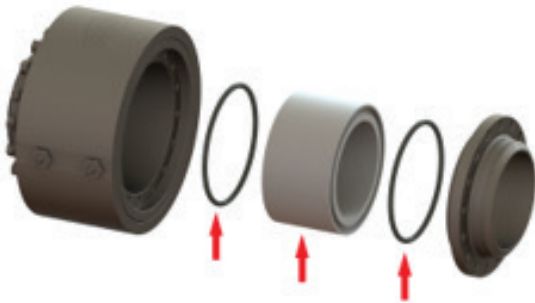

**4** Lubricate the seal gland areas located on bottom of nose pieces touching the O-rings, the new H-ring seal grooves, and O-rings with grease.



**5** Install the replacement O-rings and the new H-ring. Make sure the O-rings are set in each groove on the top and bottom of the H-ring. Be careful not to pinch the O-rings during reassembly.

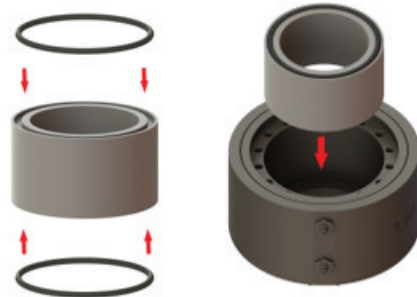

**6** Reinstall the nose piece using the new bolts and washers in the replacement kit. Do not reuse old bolts and washers.

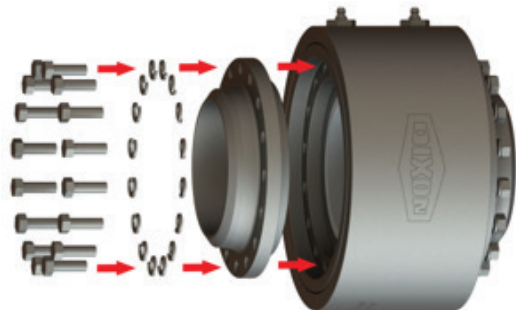

**7** Torque the bolts to 25 ft-lbs. in a star pattern



Pressure testing is recommended prior to returning the swivel joint to service. If needed, this is a good time to clean and repaint any carbon steel parts to help protect them from corrosion.

Once the seal replacement and pressure testing are complete the unit can be returned to service.

### Dixon® Loading Arms

A loading arm is a dynamic system allowing for the transfer of media such as liquids, liquified gas, or dry bulk from one storage vessel to another. Consisting of a combination of swivel joints, pipe and/or hose legs, a counterbalance, and various end connections, loading arms can be configured for both top loading and bottom loading applications. Dixon loading arms are ideal for a wide range of applications, transferring product to and from tank trucks or rail cars as well as to drums and totes.

#### Sizes

- 2", 3", 4", 6", and more upon request

#### Features

- Engineered with serviceability in mind
- Counterbalance options include compression springs, torsion springs, and counterweights
- Standard and customized options available
- Torsion spring counterbalance offered in left and right hand
- Multiple spring rates available for different load requirements
- Counterweight option available with 2 or 4 sliding weights
- Wide variety of end connections and accessories available

#### Materials

- Pipe leg materials offered: aluminum, carbon steel, and 316 stainless steel
- Available seals include: nitrile rubber, FKM, low-temperature FKM, PTFE, EPDM, and food-grade nitrile
- Drop hoses available in composite or stainless steel

NOTE: Visit [canada.dixonvalve.com/en/dixon-loading-arms](http://canada.dixonvalve.com/en/dixon-loading-arms) for additional product information or call 888.226.4673.

### Dixon Loading Arm Configurations

#### Counterweight Loading Arms

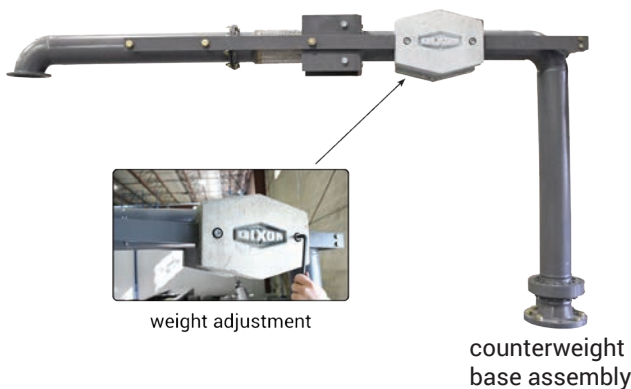

#### A-Frame Loading Arm with Rigid Drop Pipe



#### A-Frame Loading Arm with Drop Hose



#### Horizontal Hose Loader



### Dixon® Loading Arm Configurations

Fixed Reach Loading Arm



Telescoping Loading Arm

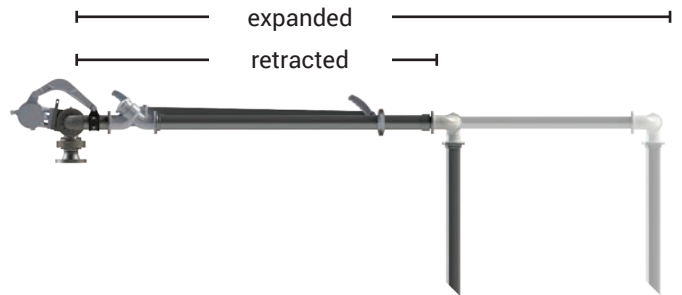

Scissor Style Loading Arm



Unsupported Boom Loading Arm



Supported Boom Loading Arm



**Additional  
Sizes and Configurations  
Coming  
Soon!**

NOTE: Visit [canada.dixonvalve.com/en/dixon-loading-arms](http://canada.dixonvalve.com/en/dixon-loading-arms) for additional product information or call 877.963.4966.

**Base Swivels with Counterbalance**



left hand style



right hand style

**Sizes**

- Carbon steel V-ring: 3", 4", and 6"
- Carbon steel split flange: 2", 3", and 4"
- 316 stainless steel split flange: 2", 3", and 4"

**Features**

- Torsion spring counterbalance offered in right or left hand
- Style 50 or 70 available for base swivels based on configuration and flow of media
- Connecting arm and clamp included

**Materials**

- Base swivel materials offered: carbon steel and 316 stainless steel
- Available seals include: nitrile rubber, FKM, low temperature FKM, PTFE, EPDM, or food-grade nitrile rubber

**Specifications**

- Standard configurations below include carbon steel split flange base swivel, ESB1 torsion spring counterbalance, 150# flange inlet, and TTMA flange outlet
- Connection options include: 150# flange, 300# flange, and TTMA flange
- Other options available upon request
- Three spring rates available: Light, medium, and heavy. Contact Dixon® to determine which is best for your application.

| Orientation | Seals          | Counterbalance Spring | 3" Part #       | 4" Part #       |
|-------------|----------------|-----------------------|-----------------|-----------------|
| UFRH        | Nitrile rubber | Light                 | AB3G00000000000 | AB4G00000000000 |
|             |                | Medium                | BB3G00000000000 | BB4G00000000000 |
|             |                | Heavy                 | CB3G00000000000 | CB4G00000000000 |
|             | FKM            | Light                 | AV3G00000000000 | AV4G00000000000 |
|             |                | Medium                | BV3G00000000000 | BV4G00000000000 |
|             |                | Heavy                 | CV3G00000000000 | CV4G00000000000 |
| UFLH        | Nitrile rubber | Light                 | EB3G00000000000 | EB4G00000000000 |
|             |                | Medium                | FB3G00000000000 | FB4G00000000000 |
|             |                | Heavy                 | GB3G00000000000 | GB4G00000000000 |
|             | FKM            | Light                 | EV3G00000000000 | EV4G00000000000 |
|             |                | Medium                | FV3G00000000000 | FV4G00000000000 |
|             |                | Heavy                 | GV3G00000000000 | GV4G00000000000 |



upfeed right-hand (UFRH)

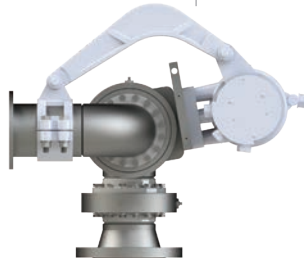

upfeed left-hand (UFLH)



horizontal upfeed right-hand (HUFHR)\*

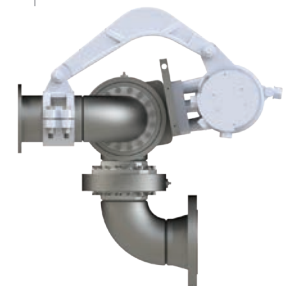

horizontal upfeed left-hand (HUFHL)\*

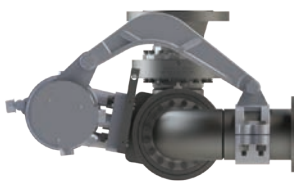

downfeed right-hand (DFRH)\*

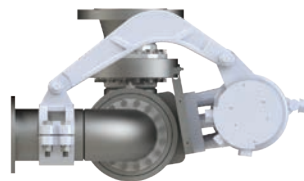

downfeed left-hand (DFLH)\*



horizontal downfeed right-hand (HDFRH)\*

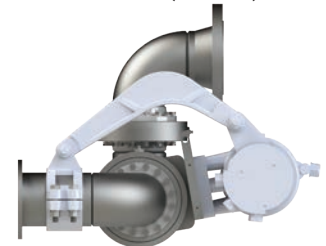

horizontal downfeed left-hand (HDFLH)\*

\*Not listed in chart above, contact Dixon® for details



## Loading Arm Swivels

### Features

- TTMA-flanged aluminum loading arm swivel
- Optional D-handle or ball handle is used to guide the connection of the API load coupler to the adapter on the tank truck
- Optional long radius elbow improves the flow into the API load coupler and provides spacing between the load arm and the tank truck
- Can be used with flange extensions and other TTMA flanged accessories
- Available seals include: nitrile rubber, FKM, low temperature FKM, EPDM, or food-grade nitrile

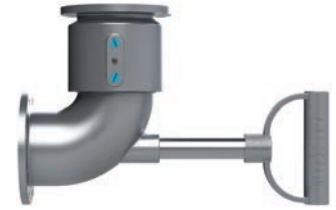

style 30, short radius



style 30, long radius

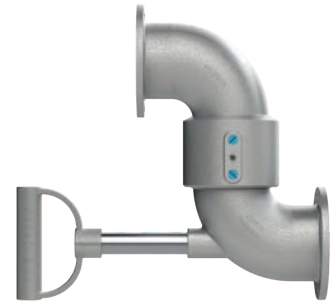

style 40

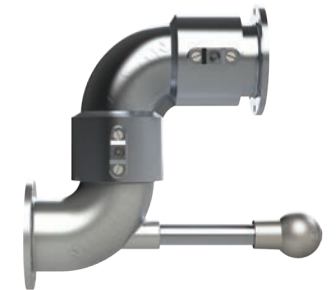

style 50

| Description           | Handle      | Seal           | 3" Part #       | 4" Part #       |
|-----------------------|-------------|----------------|-----------------|-----------------|
| style 20              | no handle   | Nitrile rubber | 320TFXTFAL00000 | 420TFXTFAL00000 |
|                       |             | FKM            | 320TFXTFAL11000 | 420TFXTFAL11000 |
| style 30 short radius | D-handle    | Nitrile rubber | 33HTFXTFAL00000 | 43HTFXTFAL00000 |
|                       |             | FKM            | 33HTFXTFAL11000 | 43HTFXTFAL11000 |
|                       | ball handle | Nitrile rubber | 33BTFXTFAL00000 | 43BTFXTFAL00000 |
|                       |             | FKM            | 33BTFXTFAL11000 | 43BTFXTFAL11000 |
|                       | no handle   | Nitrile rubber | 330TFXTFAL00000 | 430TFXTFAL00000 |
|                       |             | FKM            | 330TFXTFAL11000 | 430TFXTFAL11000 |
| style 30 long radius  | D-handle    | Nitrile rubber | --              | 43HTFTFLAL00000 |
|                       |             | FKM            | --              | 43HTFTFLAL11000 |
|                       | ball handle | Nitrile rubber | --              | 43BTFTFLAL00000 |
|                       |             | FKM            | --              | 43BTFTFLAL11000 |
|                       | no handle   | Nitrile rubber | --              | 430TFTFLAL00000 |
|                       |             | FKM            | --              | 430TFTFLAL11000 |
| style 40              | D-handle    | Nitrile rubber | 34HTFXTFAL00000 | 44HTFXTFAL00000 |
|                       |             | FKM            | 34HTFXTFAL11000 | 44HTFXTFAL11000 |
|                       | ball handle | Nitrile rubber | 34BTFXTFAL00000 | 44BTFXTFAL00000 |
|                       |             | FKM            | 34BTFXTFAL11000 | 44BTFXTFAL11000 |
|                       | no handle   | Nitrile rubber | 340TFXTFAL00000 | 440TFXTFAL00000 |
|                       |             | FKM            | 340TFXTFAL11000 | 440TFXTFAL11000 |
| style 50              | D-handle    | Nitrile rubber | 35HTFXTFAL00000 | 45HTFXTFAL00000 |
|                       |             | FKM            | 35HTFXTFAL11000 | 45HTFXTFAL11000 |
|                       | ball handle | Nitrile rubber | 35BTFXTFAL00000 | 45BTFXTFAL00000 |
|                       |             | FKM            | 35BTFXTFAL11000 | 45BTFXTFAL11000 |
|                       | no handle   | Nitrile rubber | 350TFXTFAL00000 | 450TFXTFAL00000 |
|                       |             | FKM            | 350TFXTFAL11000 | 450TFXTFAL11000 |

## Loading Arm Swivel Replacement Parts

| Description                      | Part #     |
|----------------------------------|------------|
| 1" schedule 80 aluminum nipple   | ATN100X7   |
| ball-style handle                | 100BHAN-AL |
| D-Style heavy-duty shovel handle | 100DHAN-AL |



100\*BHAN-AL



ATN100X7



## TTMA Weldable Flanges

### Application

- Used in applications where a device such as a valve or sight flow with a TTMA flange needs to be connected to a pipe; the TTMA weldable flange is welded to the pipe and the desired device is bolted on.

### Features

- Flanges are 3/8" thick
- Easily connect with any item that has a 3" or 4" TTMA flange

### Material

- Aluminum

### Specification

- Flange connections are manufactured to connect with the Tank Truck Manufacturers Association (TTMA) flange pattern, see page 68 for flange dimensions.



TTF3AL



TTF400SP

| Part #   | Description                     |
|----------|---------------------------------|
| TTF3AL   | 3" TTMA butt weld on flange     |
| TTF4AL   | 4" TTMA butt weld on flange     |
| TTF300SP | 3" TTMA socket weld on flange   |
| TTF400SP | 4" TTMA socket weld on flange   |
| TTMA-32C | 2" CS TTMA slip-on plate flange |
| TTMA-48C | 3" CS TTMA slip-on plate flange |
| TTMA-64C | 4" CS TTMA slip-on plate flange |

Product instruction sheets and technical data, can be viewed at [canada.dixonvalve.com](http://canada.dixonvalve.com)

## TTMA PTFE Envelope Klinger® Gasket Kit

### Features

- TTMA PTFE envelope Klinger® gasket with 3/8" bolts and self-locking nuts

### Sizes

- 3"-4"



400GTTFTK-1758Z



400GTTFTK-3008Z

| Size | Bolt Length | Part #          |
|------|-------------|-----------------|
| 3"   | 1-1/2"      | 300GTTFTK-1508Z |
|      | 1-3/4"      | 300GTTFTK-1758Z |
|      | 2"          | 300GTTFTK-2008Z |
|      | 3"          | 300GTTFTK-3008Z |
|      | 3-1/2"      | 300GTTFTK-3508Z |
| 4"   | 1-1/2"      | 400GTTFTK-1508Z |
|      | 1-3/4"      | 400GTTFTK-1758Z |
|      | 2"          | 400GTTFTK-2008Z |
|      | 3"          | 400GTTFTK-3008Z |
|      | 3-1/2"      | 400GTTFTK-3508Z |

## TTMA Baylast™ Gasket Kit

### Features

- TTMA Baylast gasket with 3/8" bolts and self-locking nuts

### Sizes

- 3"-4"



400GTTFBL-1758Z



400GTTFBL-3008Z

| Size | Bolt Length | Part #          |
|------|-------------|-----------------|
| 3"   | 1-1/2"      | 300GTTFBL-1508Z |
|      | 1-3/4"      | 300GTTFBL-1758Z |
|      | 2"          | 300GTTFBL-2008Z |
|      | 3"          | 300GTTFBL-3008Z |
|      | 3-1/2"      | 300GTTFBL-3508Z |
| 4"   | 1-1/2"      | 400GTTFBL-1508Z |
|      | 1-3/4"      | 400GTTFBL-1758Z |
|      | 2"          | 400GTTFBL-2008Z |
|      | 3"          | 400GTTFBL-3008Z |
|      | 3-1/2"      | 400GTTFBL-3508Z |

### TTMA Flange Gaskets

| Size | O.D.     | I.D.    | Thk.  | Material                          | Part #    |
|------|----------|---------|-------|-----------------------------------|-----------|
| 2"   | 4-1/2"   | 2-5/8"  | 1/8"  | Baylast™                          | 200GTTFBL |
|      | 5-5/8"   | 3-1/2"  | 1/8"  | Cork / nitrile rubber             | 300GTTFCB |
|      | 5-5/16"  | 3-1/4"  | 5/32" | PTFE envelope with Klinger filler | 300GTTFTK |
| 3"   | 5-5/8"   | 3-1/2"  | 1/8"  | Klingersil® C-4300                | 300GTTFK  |
|      | 5-29/32" | 3-1/2"  | 3/32" | PTFE with fiber core              | 40321TF   |
|      | 7-1/4"   | 5"      | 5/32" | PTFE with soft fiber core         | 40364TF   |
|      | 7-1/4"   | 5"      | 1/8"  | Baylast                           | 40364BL   |
|      | 5-5/8"   | 3-5/8"  | 1/8"  | Baylast                           | 300GTTFBL |
| 4"   | 6-5/8"   | 4-9/16" | 1/8"  | Cork / nitrile rubber             | 400GTTFCB |
|      | 6-7/8"   | 4-5/16" | 5/32" | PTFE envelope with Klinger filler | 400GTTFTK |
|      | 6-5/8"   | 4-9/16" | 1/8"  | Klingersil C-4401                 | 400GTTFK  |
|      | 6-7/8"   | 4-9/16" | 3/32" | PTFE with fiber core              | 40322TF   |
|      | 8-3/8"   | 5-7/8"  | 5/32" | PTFE with soft fiber core         | 40323TF   |
|      | 8-1/4"   | 5-7/8"  | 1/8"  | Baylast                           | 40323BL   |
|      | 6-5/8"   | 4-5/8"  | 1/8"  | Baylast                           | 400GTTFBL |



NOTE: For flange dimensions, diagrams, and additional information, please reference [canada.dixonvalve.com](http://canada.dixonvalve.com).

### 150 lb. Flange Gaskets

**Features**

- Standard drop-ring type all 1/16" thick
- For flange dimensional information and diagrams please reference [canada.dixonvalve.com](http://canada.dixonvalve.com)

| Size   | Neoprene Part # | PTFE Part # |
|--------|-----------------|-------------|
| 1"     | NG10            | ---         |
| 1-1/4" | NG15            | ---         |
| 1-1/2" | NG20            | ---         |
| 2"     | NG25            | PG25        |
| 2-1/2" | NG30            | ---         |
| 3"     | NG35            | PG35        |
| 4"     | NG40            | PG40        |
| 5"     | NG50            | ---         |
| 6"     | NG60            | PG60        |
| 8"     | NG80            | ---         |



neoprene



PTFE

### 150 lb. PTFE Flange Gasket Kit

**Features**

- 150 lb. PTFE flange gasket with 5/8" bolts, nuts, and lock washers

**Sizes**

- 3"-4"

| Size | Bolt Length | Part #     |
|------|-------------|------------|
| 3"   | 3"          | PG35-3008Z |
|      | 3-1/2"      | PG35-3508Z |
| 4"   | 3"          | PG40-3008Z |
|      | 3-1/2"      | PG40-3508Z |



PG35-3008Z

### 150 lb. Neoprene Flange Gasket Kit

**Features**

- 150 lb. neoprene flange gasket with 5/8" bolts, nuts, and lock washers

**Sizes**

- 3"-4"

| Size | Bolt Length | Part #     |
|------|-------------|------------|
| 3"   | 3"          | NG35-3008Z |
|      | 3-1/2"      | NG35-3508Z |
| 4"   | 3"          | NG40-3008Z |
|      | 3-1/2"      | NG40-3508Z |



NG40-3008Z

## 150 lb. ANSI Forged Flanges

**Sizes**

- 1" - 12"

**Features**

- Raised face: Slip-On and Weld Neck

**Materials**

- Carbon steel
- 316 stainless steel

### 150 lb. Slip-On Flange



150 lb. Slip-On Flange

| Size   | Number of Bolts | Carbon Steel Part # | 316 Stainless steel Part # |
|--------|-----------------|---------------------|----------------------------|
| 1"     | 4               | SO100               | SOR100                     |
| 1-1/4" | 4               | SO125               | --                         |
| 1-1/2" | 4               | SO150               | SOR150                     |
| 2"     | 4               | SO200               | SOR200                     |
| 2-1/2" | 4               | SO250               | --                         |
| 3"     | 4               | SO300               | SOR300                     |
| 4"     | 8               | SO400               | SOR400                     |
| 5"     | 8               | SO500               | --                         |
| 6"     | 8               | SO600               | SOR600                     |
| 8"     | 8               | SO800               | SOR800                     |
| 10"    | 12              | SO1000              | SOR1000                    |
| 12"    | 12              | SO1200              | SOR1200                    |

### 150 lb. Weld Neck Flange



150 lb. Weld Neck Flange

| Size   | Number of Bolts | Carbon Steel Part # | 316 Stainless steel Part # |
|--------|-----------------|---------------------|----------------------------|
| 1"     | 4               | WN100               | WNR10015                   |
| 1-1/4" | 4               | WN125               | WNR12515                   |
| 1-1/2" | 4               | WN150               | WNR15015                   |
| 2"     | 4               | WN200               | WNR20015                   |
| 2-1/2" | 4               | WN250               | WNR25015                   |
| 3"     | 4               | WN300               | WNR30015                   |
| 4"     | 8               | WN400               | WNR40015                   |
| 5"     | 8               | WN500               | WNR50015                   |
| 6"     | 8               | WN600               | WNR60015                   |
| 8"     | 8               | WN800               | WNR80015                   |
| 10"    | 12              | WN1000              | WNR100015                  |
| 12"    | 12              | WN1200              | WNR120015                  |

### NPT Threaded One End Pipe Fittings

| Size   | Overall Length | Carbon Steel Part # | 316 Stainless Steel Part # | Aluminum Part # |
|--------|----------------|---------------------|----------------------------|-----------------|
| 1"     | 2"             | PN1000              | ---                        | ---             |
| 1-1/4" | 2"             | PN1250              | ---                        | ---             |
| 1-1/2" | 2"             | PN1500              | PNR1500                    | ---             |
| 2"     | 2"             | PN2000              | PNR2000                    | APN2000         |
| 2-1/2" | 3"             | PN2500              | ---                        | ---             |
| 3"     | 3"             | PN3000              | PNR3000                    | APN3000         |
| 4"     | 4"             | PN4000              | PNR4000                    | APN4000         |



PN3000

### NPT Threaded Female Half Couplings

| Size   | Carbon Steel Part # | 316 Stainless Steel Part # | Aluminum Part # |
|--------|---------------------|----------------------------|-----------------|
| 1"     | 1HCPLGCS            | 1HCPLGSS                   | 1HCPLGAL        |
| 1-1/4" | 125HCPLGCS          | 125HCPLGSS                 | 125HCPLGAL      |
| 1-1/2" | 150HCPLGCS          | 150HCPLGSS                 | 150HCPLGAL      |
| 2"     | 2HCPLGCS            | 2HCPLGSS                   | 2HCPLGAL        |
| 2-1/2" | 250HCPLGCS          | 250HCPLGSS                 | 250HCPLGAL      |
| 3"     | 3HCPLGCS            | 3HCPLGSS                   | 3HCPLGAL        |
| 4"     | 4HCPLGCS            | 4HCPLGSS                   | 4HCPLGAL        |



150HCPLGSS

### Grease Fittings

| Carbon Steel without Ball Check Part # | Carbon Steel with Ball Check Part # | 316 Stainless Steel with Ball Check Part # |
|--|-------------------------------------|--|
| GP                                     | GPBCCS                              | GPBCCS                                     |



GP

### Set Screws

| Size  | Carbon Steel Part # | 316 Stainless Steel Part # |
|-------|---------------------|----------------------------|
| 3/8"  | 38SET               | 38SETSS                    |
| 7/16" | 716SET              | 716SETSS                   |
| 5/8"  | 58SET               | 58SETSS                    |
| 7/8"  | 78SET               | 78SETSS                    |
| 9/8"  | 98SET               | 98SETSS                    |



78SET



38SET

### TTMA Handle Kits



TTMAHK-C



TTMAHK-LB

**Application**

- For various applications that utilize 4" TTMA connections, allowing for improved ergonomics when handling hoses

**Features**

- Mounting plate mates up to TTMA flange
- Lightweight construction

| Size | Description           | Aluminum Part # |
|------|-----------------------|-----------------|
| 4"   | Compact with D-handle | TTMAHK-C        |
| 4"   | Long with ball handle | TTMAHK-LB       |

NOTE: Nuts and bolts not included

### Thread Sealant Paste

**Application**

- Not for use in oxygen applications



**Specification**

- Temperature range: -50°F to 400°F (-45°C to 204°C)



| Size     | Part # | Optional Qty |
|----------|--------|--------------|
| 1/4 pint | LCTS14 | 24           |
| 1/2 pint | LCTS1  | 24           |
| 1 pint   | LCTS2  | 12           |
| 1 quart  | LCTS3  | 12           |

### Joint Sealant Gasket Material

**Features**

- GORE-TEX interchangeable
- Form-in-place expanded PTFE gasket material with adhesive backing
- Manufactured from 100% virgin PTFE
- Unaffected by all common chemicals (pH from 0-14)
- Unlimited shelf life
- Resilient with low cold flow
- Requires less force than standard gasket materials
- Made in the USA
- Larger spools are available; consult Dixon® for price and availability

**Specifications**

- Pressure range: **vacuum to 3000 PSI**
- Temperature range: **-450°F to 600°F (-268°C to 316°C)**

**Approval**

- FDA compliant #21CFR177.1550



| Size | Length | Part #    |
|------|--------|-----------|
| 1/4" | 20'    | LCJS4-20  |
| 1/4" | 50'    | LCJS4-50  |
| 3/8" | 25'    | LCJS6-25  |
| 1/2" | 15'    | LCJS8-15  |
| 3/4" | 15'    | LCJS12-15 |

### American Made PTFE Tape (Purple)

**Features**

- Superior quality
- Not for use in oxygen applications

**Specifications**

- Temperature range: -450°F to 500°F (-268°C to 260°C)
- Thickness: 3.5 mil (0.0035 mm)

| Size | Length | Part #       |
|------|--------|--------------|
| 1/2" | 520"   | TTPM50-520   |
|      | 700"   | TTPM50-700   |
|      | 1429"  | TTPM50-1429  |
| 3/4" | 520"   | TTPM75-520   |
|      | 700"   | TTPM75-700   |
|      | 1429"  | TTPM75-1429  |
| 1"   | 520"   | TTPM100-520  |
|      | 700"   | TTPM100-700  |
|      | 1429"  | TTPM100-1429 |



### Industrial PTFE Tape (White)

**Feature**

- Not for use in oxygen applications

**Specifications**

- Thickness: 3.5 mil (0.0035 mm)
- Temperature range: -212°F to 500°F (-136°C to 260°C)

| Size | Length | Part # | Optional Qty |
|------|--------|--------|--------------|
| 1/2" | 260"   | TTA50  | 550          |
|      | 520"   | TTB50  | 500          |
|      | 1296"  | TTC50  | 250          |
| 3/4" | 260"   | TTA75  | 350          |
|      | 520"   | TTB75  | 350          |
| 1"   | 520"   | TTB100 | 250          |



### Stainless Steel PTFE Tape (Gray)

**Application**

- Useful on stainless steel threaded joints or connections

**Features**

- Not for use in oxygen applications
- PTFE with nickel added, nickel acts like a ball bearing
- Made in the U.S.

**Specifications**

- Thickness: 4 mil
- Temperature range: -450°F to 550°F (-268°C to 288°C)

| Size | Length | Part #  | Optional Qty |
|------|--------|---------|--------------|
| 1/2" | 260"   | TTA50SS | 10           |



### Industrial Heavy Duty PTFE Tape (Pink)

**Feature**

- Not for use in oxygen applications

**Specifications**

- Thickness: 4 mil
- Temperature range: -400°F to 500°F (-240°C to 260°C)

| Size | Length | Part # | Optional Qty |
|------|--------|--------|--------------|
| 1/2" | 540"   | TTBP50 | 500          |



### PTFE Tape for LP Gas (Yellow)

**Feature**

- Not for use in oxygen applications

**Approval**

- Underwriters Listed

**Specifications**

- Thickness: 4 mil
- Maximum temperature: 500°F (260°C)

| Size | Length | Part #  | Optional Qty |
|------|--------|---------|--------------|
| 1/2" | 260"   | TTA50LP | 500          |



### Flange Bolt Tightening Sequence

(Use appropriate gaskets and bolts)

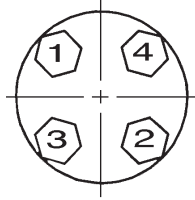

4 Bolt

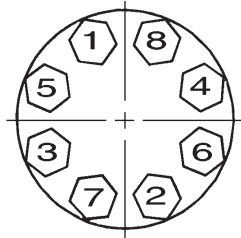

8 Bolt

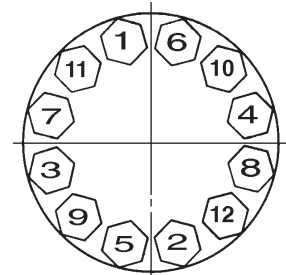

12 Bolt

### Flange Diagrams

#### Threaded Applications

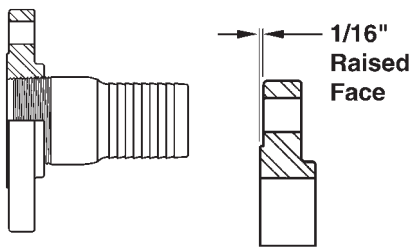

Threaded flange with raised face

#### Welded Applications

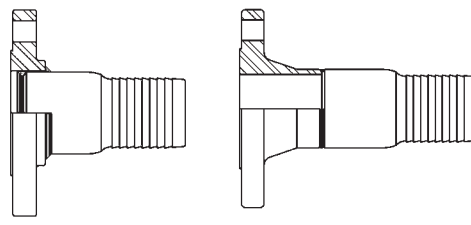

Slip-on flange with raised face

Weld neck flange with raised face

#### Floating Applications (flange free to swivel)

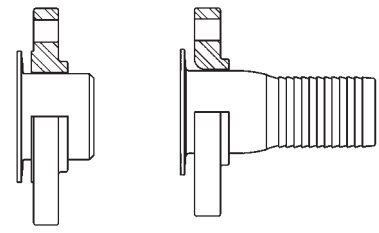

Slip-on flange with raised face

Lap-joint flange

### Dimensions of 150 Lb. ASA Steel Flanges

| Nominal Pipe Size | Flange O.D. | Thickness <sup>1</sup> | O.D. of Raised Face | Diameter of Bolt Circle | Number of Bolts | Diameter of Bolt Holes | Diameter of Bolts |
|-------------------|-------------|------------------------|---------------------|-------------------------|-----------------|------------------------|-------------------|
| 1"                | 4-1/4"      | 9/16"                  | 2"                  | 3-1/8"                  | 4               | 5/8"                   | 1/2"              |
| 1-1/4"            | 4.62"       | 5/8"                   | 2-1/2"              | 3-1/2"                  | 4               | 5/8"                   | 1/2"              |
| 1-1/2"            | 5"          | 11/16"                 | 2-7/8"              | 3-7/8"                  | 4               | 5/8"                   | 1/2"              |
| 2"                | 6"          | 3/4"                   | 3-5/8"              | 4-3/4"                  | 4               | 3/4"                   | 5/8"              |
| 2-1/2"            | 7"          | 7/8"                   | 4-1/8"              | 5-1/2"                  | 4               | 3/4"                   | 5/8"              |
| 3"                | 7-1/2"      | 15/16"                 | 5"                  | 6"                      | 4               | 3/4"                   | 5/8"              |
| 4"                | 9"          | 15/16"                 | 6-3/16"             | 7-1/2"                  | 8               | 3/4"                   | 5/8"              |
| 5"                | 10"         | 15/16"                 | 7-5/16"             | 8-1/2"                  | 8               | 7/8"                   | 3/4"              |
| 6"                | 11"         | 1"                     | 8-1/2"              | 9-1/2"                  | 8               | 7/8"                   | 3/4"              |
| 8"                | 13-1/2"     | 1-1/8"                 | 10-5/8"             | 11-3/4"                 | 8               | 7/8"                   | 3/4"              |
| 10"               | 16"         | 1-3/16"                | 12-3/4"             | 14-1/4"                 | 12              | 1"                     | 7/8"              |
| 12"               | 19"         | 1 1/4"                 | 15"                 | 17"                     | 12              | 1"                     | 7/8"              |

<sup>1</sup> 1/16" raised face is included in the thickness

### Dimensions of Tank Truck Flanges (TTMA Drilling)

| Nominal Pipe Size | Flange O.D. | Thickness <sup>1</sup> | Diameter of Bolt Circle | Number of Bolts | Diameter of Bolt Holes | Diameter of Bolts |
|-------------------|-------------|------------------------|-------------------------|-----------------|------------------------|-------------------|
| 3"                | 5-5/8"      | 3/8"                   | 4-7/8"                  | 8               | 7/16"                  | 3/8"              |
| 4"                | 6-5/8"      | 3/8"                   | 5-7/8"                  | 8               | 7/16"                  | 3/8"              |
| 6"                | 8-7/8"      | 3/8"                   | 8-1/8"                  | 12              | 7/16"                  | 3/8"              |

<sup>1</sup> Listed thickness is for aluminum flanges



## ANSI Flange Dimensions

### 150 lb. Standard

| Nominal Pipe Size | Outside Diameter Flange | Flange Thickness | Drill Template |                |             |
|-------------------|-------------------------|------------------|----------------|----------------|-------------|
|                   |                         |                  | Number Holes   | Diameter Bolts | Bolt Circle |
| 1/2"              | 3-1/2"                  | 7/16"            | 4              | 1/2"           | 2-3/8"      |
| 3/4"              | 3-7/8"                  | 1/2"             | 4              | 1/2"           | 2-3/4"      |
| 1"                | 4-1/4"                  | 9/16"            | 4              | 1/2"           | 3-1/8"      |
| 1-1/4"            | 4-5/8"                  | 5/8"             | 4              | 1/2"           | 3-1/2"      |
| 1-1/2"            | 5"                      | 11/16"           | 4              | 1/2"           | 3-7/8"      |
| 2"                | 6"                      | 3/4"             | 4              | 5/8"           | 4-3/4"      |
| 2-1/2"            | 7"                      | 7/8"             | 4              | 5/8"           | 5-1/2"      |
| 3"                | 7-1/2"                  | 15/16"           | 4              | 5/8"           | 6"          |
| 3-1/2"            | 8-1/2"                  | 15/16"           | 8              | 5/8"           | 7"          |
| 4"                | 9"                      | 15/16"           | 8              | 5/8"           | 7-1/2"      |
| 5"                | 10"                     | 15/16"           | 8              | 3/4"           | 8-1/2"      |
| 6"                | 11"                     | 1"               | 8              | 3/4"           | 9-1/2"      |
| 8"                | 13-1/2"                 | 1-1/8"           | 8              | 3/4"           | 11-3/4"     |
| 10"               | 16"                     | 1-3/16"          | 12             | 3/4"           | 14-1/4"     |
| 12"               | 19"                     | 1-1/4"           | 12             | 3/4"           | 17"         |

### 300 lb. Standard

| Nominal Pipe Size | Outside Diameter Flange | Flange Thickness | Drill Template |                |             |
|-------------------|-------------------------|------------------|----------------|----------------|-------------|
|                   |                         |                  | Number Holes   | Diameter Bolts | Bolt Circle |
| 1/2"              | 3-3/4"                  | 9/16"            | 4              | 1/2"           | 2-5/8"      |
| 3/4"              | 4-5/8"                  | 5/8"             | 4              | 5/8"           | 3-1/4"      |
| 1"                | 4-7/8"                  | 11/16"           | 4              | 5/8"           | 3-1/2"      |
| 1-1/4"            | 5-1/4"                  | 3/4"             | 4              | 5/8"           | 3-7/8"      |
| 1-1/2"            | 6-1/8"                  | 13/16"           | 4              | 3/4"           | 4-1/2"      |
| 2"                | 6-1/2"                  | 7/8"             | 8              | 5/8"           | 5"          |
| 2-1/2"            | 7-1/2"                  | 1"               | 8              | 3/4"           | 5-7/8"      |
| 3"                | 8-1/4"                  | 1-1/8"           | 8              | 3/4"           | 6-5/8"      |
| 3-1/2"            | 9"                      | 1-3/16"          | 8              | 3/4"           | 7-1/4"      |
| 4"                | 10"                     | 1-1/4"           | 8              | 3/4"           | 7-7/8"      |
| 5"                | 11"                     | 1-3/8"           | 8              | 3/4"           | 9-1/4"      |
| 6"                | 12-1/2"                 | 1-7/16"          | 12             | 3/4"           | 10-5/8"     |
| 8"                | 15"                     | 1-5/8"           | 12             | 7/8"           | 13"         |
| 10"               | 17-1/2"                 | 1-7/8"           | 16             | 1"             | 15-1/4"     |
| 12"               | 20-1/2"                 | 2"               | 16             | 1-1/8"         | 17-3/4"     |

### 600 lb. Standard

| Nominal Pipe Size | Outside Diameter Flange | Flange Thickness | Drill Template |                |             |
|-------------------|-------------------------|------------------|----------------|----------------|-------------|
|                   |                         |                  | Number Holes   | Diameter Bolts | Bolt Circle |
| 1/2"              | 3-3/4"                  | 9/16"            | 4              | 5/8"           | 2-5/8"      |
| 3/4"              | 4-5/8"                  | 5/8"             | 4              | 3/4"           | 3-1/4"      |
| 1"                | 4-7/8"                  | 11/16"           | 4              | 3/4"           | 3-1/2"      |
| 1-1/4"            | 5-1/4"                  | 13/16"           | 4              | 3/4"           | 3-7/8"      |
| 1-1/2"            | 6-1/8"                  | 7/8"             | 4              | 7/8"           | 4-1/2"      |
| 2"                | 6-1/2"                  | 1"               | 8              | 3/4"           | 5"          |
| 2-1/2"            | 7-1/2"                  | 1-1/8"           | 8              | 7/8"           | 5-7/8"      |
| 3"                | 8-1/4"                  | 1-1/4"           | 8              | 7/8"           | 6-5/8"      |
| 3-1/2"            | 9"                      | 1-3/8"           | 8              | 1"             | 7-1/4"      |
| 4"                | 10-7/5"                 | 1-1/2"           | 8              | 1"             | 8-1/2"      |
| 5"                | 13"                     | 1-3/4"           | 8              | 1-1/8"         | 10-1/2"     |
| 6"                | 14"                     | 1-7/8"           | 12             | 1-1/8"         | 11-1/2"     |
| 8"                | 16-1/2"                 | 2-3/16"          | 12             | 1-1/4"         | 13-3/4"     |
| 10"               | 20"                     | 2-1/2"           | 16             | 1-3/8"         | 17"         |
| 12"               | 22"                     | 2-5/8"           | 20             | 1-3/8"         | 19-1/4"     |

### 900 lb. Standard

| Nominal Pipe Size | Outside Diameter Flange | Flange Thickness | Drill Template |                |             |
|-------------------|-------------------------|------------------|----------------|----------------|-------------|
|                   |                         |                  | Number Holes   | Diameter Bolts | Bolt Circle |
| 1/2"              | 4-3/4"                  | 7/8"             | 4              | 7/8"           | 3-1/4"      |
| 3/4"              | 5-1/8"                  | 1"               | 4              | 7/8"           | 3-1/2"      |
| 1"                | 5-7/8"                  | 1-1/8"           | 4              | 1"             | 4"          |
| 1-1/4"            | 6-1/4"                  | 1-1/8"           | 4              | 1"             | 4-3/8"      |
| 1-1/2"            | 7"                      | 1-1/4"           | 4              | 1-1/8"         | 4-7/8"      |
| 2"                | 8-1/2"                  | 1-1/2"           | 8              | 1"             | 6-1/2"      |
| 2-1/2"            | 9-5/8"                  | 1-5/8"           | 8              | 1-1/8"         | 7-1/2"      |
| 3"                | 9-1/2"                  | 1-1/2"           | 8              | 1"             | 7-1/2"      |
| 3-1/2"            | 11-1/2"                 | 1-3/4"           | 8              | 1-1/4"         | 9-1/4"      |
| 4"                | 13-3/4"                 | 2"               | 8              | 1-3/8"         | 11"         |
| 6"                | 15"                     | 2-3/16"          | 12             | 1-1/4"         | 12-1/2"     |
| 8"                | 18-1/2"                 | 2-1/2"           | 12             | 1-1/2"         | 15-1/2"     |
| 10"               | 21-1/2"                 | 2-3/4"           | 16             | 1-1/2"         | 18-1/2"     |
| 12"               | 24"                     | 3-1/8"           | 20             | 1-1/2"         | 21"         |

**Pressure Rating Chart**

Spool or rotating assembly only - Pressure rating of final assembly may be derated due to end connections

| Swivel Type                | Material        | 1"   | 1-1/4" | 1-1/2" | 2"   | 2-1/2" | 3"   | 4"   | 5"   | 6"   | 8"   | 10"  | 12"  | 14"  | 16" | 18"  | 20" | 24" |  |
|----------------------------|-----------------|------|--------|--------|------|--------|------|------|------|------|------|------|------|------|-----|------|-----|-----|--|
| O-Ring                     | Aluminum        | 150  | 150    | 150    | 150  | 150    | 150  | 150  |      |      |      |      |      |      |     |      |     |     |  |
|                            | Brass           |      |        | 300    | 300  |        | 300  |      |      |      |      |      |      |      |     |      |     |     |  |
|                            | Ductile Iron    |      |        | 600    | 600  |        | 600  | 600  |      |      |      |      |      |      |     |      |     |     |  |
|                            | Carbon Steel    | 1000 | *      | 1000   | 1000 | 1000   | 1000 | 1000 |      |      |      |      |      |      |     |      |     |     |  |
|                            | Stainless Steel | 1000 | *      | 1000   | 1000 | 1000   | 1000 |      |      |      |      |      |      |      |     |      |     |     |  |
| V-Ring                     | Aluminum        |      |        |        |      |        |      |      |      | 150  | 150  |      |      |      |     |      |     |     |  |
|                            | Carbon Steel    |      |        |        | 1000 | 1000   | 1000 | 1000 | 1000 | 1000 | 1000 | 1000 | 1000 | 1000 |     |      |     |     |  |
|                            | Stainless Steel |      |        |        | 1000 | 1000   | 1000 | 1000 | 1000 | 1000 | 1000 | 1000 | 1000 | *    |     |      |     |     |  |
| Cap Seal                   | Carbon Steel    |      |        |        |      |        |      |      |      |      |      |      |      | 1000 | 800 | 1000 | 900 | 800 |  |
|                            | Stainless Steel |      |        |        |      |        |      |      |      |      |      |      |      | *    | 800 | 1000 | *   | *   |  |
| Split Flange               | Aluminum        |      |        |        | 600  |        | 600  | 600  |      |      |      |      |      |      |     |      |     |     |  |
|                            | Carbon Steel    |      |        |        | 600  |        | 600  | 600  |      |      |      |      |      |      |     |      |     |     |  |
|                            | Stainless Steel |      |        |        | 600  |        | 600  | 600  |      |      |      |      |      |      |     |      |     |     |  |
| High Capacity Split Flange | Carbon Steel    |      |        |        | *    |        | *    | 1000 |      |      |      |      |      |      |     |      |     |     |  |
|                            | Stainless Steel |      |        |        | *    |        | *    | 1000 |      |      |      |      |      |      |     |      |     |     |  |

\* Contact Dixon for additional information

Dixon® swivels are recommended for use at the following maximum Non-Shock Cold Working Pressures (NSCWP) provided in **PSI** at ambient temperature **70°F (21°C)** for 1" – 24" sizes:



- When using flanged ends, the pressure rating will be reduced to coincide with that of the flange being used. Carbon steel and stainless steel 150# flanges are recommended for use at **275 PSI** maximum and 300# flanges at **740 PSI** at ambient temperature **70°F (21°C)**.
- TTMA flanges are recommended for use at **150 PSI** maximum at ambient temperature **70°F (21°C)**.
- Lubrication should be performed periodically, depending on service and operation conditions. Biannually is normally sufficient.
- All dimensions are approximate. Where critical, consult Dixon.

## Limited Warranty

DIXON VALVE AND COUPLING COMPANY, LLC (herein called "Dixon") warrants the products described herein and manufactured by Dixon to be free from defects in material and workmanship for a period of one (1) year from date of shipment by Dixon under normal use and service. Its sole obligation under this warranty being limited to repairing or replacing, as hereinafter provided, at its option any product found to Dixon's satisfaction to be defective upon examination by it, provided that such product shall be returned for inspection to Dixon's factory within three (3) months after discovery of the defect. The repair or replacement of defective products will be made without charge for parts or labor. This warranty shall not apply to: (a) parts or products not manufactured by Dixon, the warranty of such items being limited to the actual warranty extended to Dixon by its supplier; (b) any product that has been subject to abuse, negligence, accident, or misapplication; (c) any product altered or repaired by others than Dixon; and (d) to normal maintenance services and the replacement of service items (such as washers, gaskets, and lubricants) made in connection with such services. To the extent permitted by law, this limited warranty shall extend only to the buyer and any other person reasonably expected to use or consume the goods who is injured in person by any breach of the warranty. No action may be brought against Dixon for an alleged breach of warranty unless such action is instituted within one (1) year from the date the cause of action accrues. This limited warranty shall be construed and enforced to the fullest extent allowable by applicable law.

Other than the obligation of Dixon set forth herein, Dixon disclaims all warranties, express or implied, including but not limited to any implied warranties of merchantability or fitness for a particular purpose, and any other obligation or liability. The foregoing constitutes Dixon's sole obligation with respect to damages, whether direct, incidental, or consequential, resulting from the use or performance of the product.

Some products and sizes may be discontinued when stock is depleted or may require a minimum quantity for ordering.

## About This Brochure and Our Products

This brochure is intended as a product offering. It is not a user or technical manual. Information in this brochure is subject to change without notice. We may modify product design and specification without notice and without any obligation to modify or substitute products previously purchased. All users and distributors of products sold through this brochure are strongly encouraged to contact Dixon with questions on use, compatibilities, coupling procedures, and life of product. Our full-time engineering and test staff are always available to recommend uses and to assist distributors and users with questions.



### Safety



Safety logos, which appear throughout our brochure, are used as a reminder that the user should carefully review for the appropriateness of the product for the media, application, and environment in which it will be used.

NOTE: Because of the health hazards associated with contamination and lead content in drinking water systems, Dixon couplings, unless otherwise specifically approved, are not recommended for potable water service and should not be used in applications where drinking water will contact the wetted surfaces of the coupling.

All Dixon products are shipped in cartons with the following warning:

**"WARNING:** This product contains lead, a chemical known to the State of California to cause cancer and birth defects or other reproductive harm."

## Trademarks

Delrin® and Zytel® are registered trademarks of DuPont Nemours and Company.

Kalrez® is a registered trademark of DuPont Dow Elastomers.

All other trademarks appearing in the Dixon illustrated price list are the property of their respective owners.

## Copyright

Copyright © 2024 by Dixon Valve and Coupling, LLC

All rights reserved. This book is copyrighted material. Use, reproduction or copying of it by anyone other than Dixon® is strictly forbidden without its express written consent.

NOTE: Reasonable care has been taken in preparing this brochure. Dixon Valve & Coupling Company, LLC reserves the right to make corrections.

